

# Electronic and Non-Electronic Side-By-Side With Ice 'N Water Dispenser Refrigerator Use & Care Manual

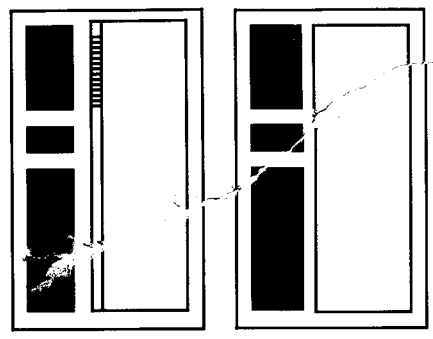

- |                 |                 |
|-----------------|-----------------|
| <b>Amana</b> 20 | <b>Amana</b> 19 |
| <b>Amana</b> 25 | <b>Amana</b> 20 |
| <b>Amana</b> 27 | <b>Amana</b> 22 |
|                 | <b>Amana</b> 25 |
|                 | <b>Amana</b> 27 |

# Welcome to the Amana Family

Your purchase of an Amana refrigerator/freezer — a household appliance known for its quality and reliability — is sincerely appreciated by Amana Refrigeration, Inc. Your total satisfaction with this new product is extremely important to us, and this Use and Care Manual will aid you in understanding the operation of your new appliance.

Each product is thoroughly tested and checked at the factory. Once in your home, you may want to make a few simple adjustments of control settings, etc., to tailor your new unit to your own individual requirements. These adjustments are easily made following the instructions in this manual.

Should your new unit ever require service, certain product information will aid in obtaining service faster! For your convenience and protection, please record this information in the box at right and retain this booklet for future reference.

The **Registration Card** in the packet with the manual should be filled out and

returned to Amana Refrigeration, Inc. If your registration card is missing, call 1-800-843-0304 or write:

Consumer Affairs  
Amana Refrigeration, Inc.  
Dept. 800  
Amana, Iowa 52204

Record in the space below the information found on the nameplate of your refrigerator. The nameplate is located on the ceiling of the refrigerator section. Also, please retain a copy of your sales receipt for future reference should warranty service be needed.

Serial No. \_\_\_\_\_

Model No. \_\_\_\_\_

Manufacturing No. \_\_\_\_\_

Selling Dealer \_\_\_\_\_

## Recognize this symbol as a safety precaution

### **WARNING**

**Electrical Grounding Instructions**—This appliance is equipped with a three-prong (grounding) plug for your protection against possible shock hazards. Where a two-prong wall receptacle is encountered, it is the personal responsibility and obligation of the customer to contact a qualified electrician and have it replaced with a properly grounded three-prong wall receptacle in accordance with the National Electrical Code (see figure.)

Unit is designed to operate on a separate 103 to 126 V.A.C., 15 amp., 60 cycle line.

**DO NOT UNDER ANY CIRCUMSTANCES CUT OR REMOVE THE ROUND GROUNDING PRONG FROM THE PLUG. THE UNIT MUST BE GROUNDED AT ALL TIMES. DO NOT REMOVE WARNING TAG FROM THE SERVICE CORD.**

ELECTRICAL PLUG

ELECTRICAL RECEPTACLE

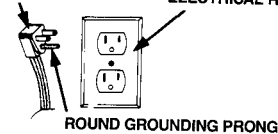

### **WARNING**

**DO NOT USE A TWO-PRONG ADAPTER.  
DO NOT USE AN EXTENSION CORD.**

## Contents

## Page

Electrical Warning .....	2
Unpacking and Door Handle Removal .....	3
Door Assembly Removal .....	5
Leveling, Door Alignment and placement .....	9
Ice 'N Water™ Dispenser .....	10
General Features .....	14
Dimensions .....	16
Setting the Controls .....	17
Checking the Controls .....	18
Touchmatic Electronic Controls .....	19
Refrigerator Features (All Models) .....	25

## Contents

## Page

Refrigerator Features (27 Cu. Ft. Models) .....	28
Refrigerator Features (19, 20, 22 & 25) .....	31
Freezer Features .....	32
Optional Features .....	33
Non-Use Periods .....	34
Sounds .....	35
Care and Cleaning .....	36
Save Energy .....	37
Before Calling for Service .....	38
Amana Asure .....	39
Amana Toll-Free .....	39

# Unpacking and Door Handle Removal

Remove all tape and packing material. To remove tape residue, touch a portion of the tape to the residue and lift it off. If adhesive residue still remains, try cleaning the sticky area with a clean cloth soaked in mild dish washing soap. Wipe area clean. If the wood base is still attached, have someone help you tilt the unit onto its back, placing a sturdy support underneath. Remove the mounting bolts from the base and discard bolts and wood base.

**IMPORTANT!** Do not leave the cabinet on its back longer than it takes to remove the wooden base and do not connect the power cord until all the inside packing has been removed and the cabinet has been leveled for proper operation.

With the unit upright, pull the grille from the bottom front and make sure the defrost drain pan is located underneath the defrost water drain tube. Two drain pan side supports (attached to the cabinet bottom) keep the pan in the proper location, to make the automatic defrost drain water drop on the sound reducing cone. The drain pan locating stops prevent the pan from being installed backwards.

Remove all tape and packing material from inside the unit.

**IMPORTANT:**  
Must Install the Defrost Drain Pan. As Shown.

Model	Location of the Defrost Drain Pan
20, 22, 25 & 27	Rightside
19	Leftside

**SPECIAL NOTE:** If cabinet is unable to fit through doorway safely, you may be required to remove the door handles, or door assemblies.

## To Remove Door Handles with Factory Installed Decorator Panels

### Non-Electronic Model

#### Tools Required:

Tightly fitted gloves, putty knife with tape on end, and 5/16" Hex Nut Driver

1. Loosen the upper and lower door handle trim and rotate 90°. See Figures 1 & 2.

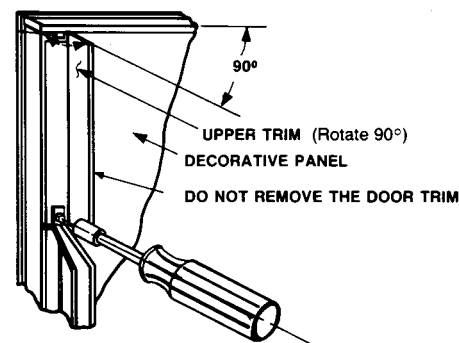
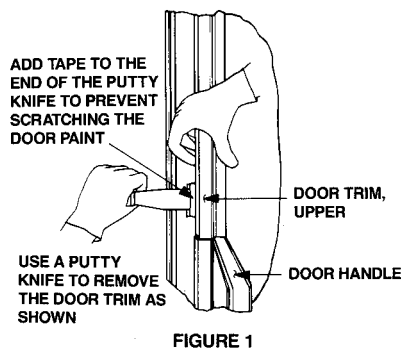

2. Remove the upper and lower door handle screws. See Figure 3.

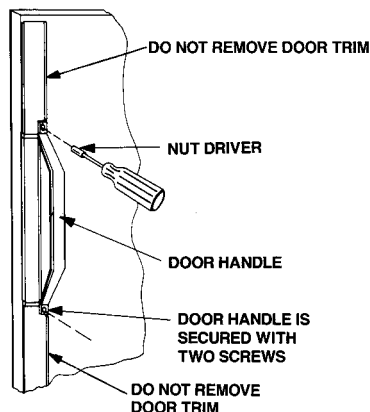

### **WARNING:**

To Avoid The Risk Of Personal Injury, Property Damage or Death, unplug the refrigerator before attempting to remove the door handles.

### **CAUTION:**

To Avoid The Risk Of Personal Injury use caution in unpacking, handling, removing, installing and cleaning all parts of product which may have sharp edges.

### **CAUTION:**

To Avoid The Risk Of Personal Injury wear protective hand covering.

# Door Handle Removal (cont.)

## To Remove The Door Handles

### Non-Electronic Models

#### Tools Required:

Tightly fitted gloves, putty knife with tape on end,  $\frac{5}{16}$ " Hex Nut Driver.

1. First remove the upper and lower door handle trim from both doors. See Figure 4.

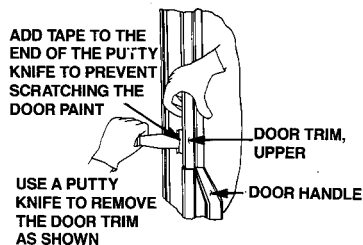

FIGURE 4

2. Remove the upper and lower door handle screws. See Figure 5.

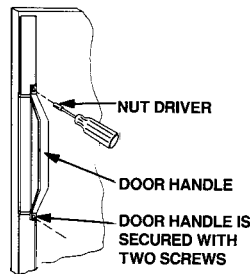

FIGURE 5

3. After moving the refrigerator past doorway replace the door handles in reverse order.

## To Remove The Door Handles

### Electronic Model

**Tools Needed:** Tightly Fitted Gloves, Putty Knife, and  $\frac{5}{16}$ " Nut Driver or Socket Wrench.

**⚠ WARNING**

To Avoid The Risk Of Personal Injury, Property Damage Or Death unplug the refrigerator before attempting to remove the door handles.

1. Add tape to the end of a putty knife to prevent scratching the door paint.
2. Use a putty knife to remove the door electronic trim as shown in Figure 6.

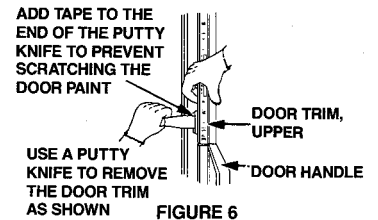

FIGURE 6

3. Lift door trim up and pull electronic strip out of connector as shown in Figure 7.

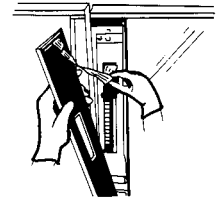

FIGURE 7

4. To remove the trim below the door handle follow step 2 above as shown in Figure 6.
5. Remove the two handle screws with a nut driver or socket wrench as shown in Figure 8.

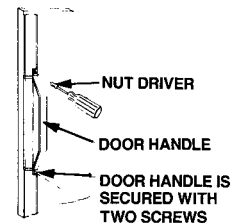

FIGURE 8

## To Reinstall The Door Handles

### Electronic Model

**Tools Needed:** Tightly Fitted Gloves, Needle Nose Plier and Nut Driver.

1. With a nut driver, screw in the two screws in the door handle.
2. Insert the electronic strip into the slit by pushing it in with a needle nose plier. See Figure 9.

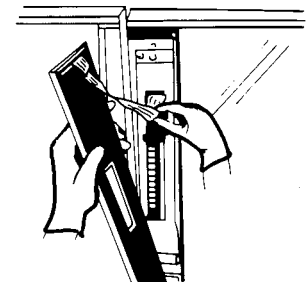

FIGURE 9

3. Once strip is in place, snap the control panel trim and trim below the handle into place.

# Door Assembly Removal

## To Remove The Door Assemblies

(Do not remove the door handles.)

### Non-Electronic Model

#### Tools Required:

Masking Tape, Tightly fitted gloves, # 2 Phillips screwdriver,  $\frac{5}{16}$ " Hex Nut Driver, Pencil,  $\frac{3}{8}$ " Hex Socket,  $\frac{3}{8}$ " Drive Ratchet and  $\frac{1}{4}$ " Hex Nut Driver.

### CAUTION:

To Avoid The Risk Of Personal Injury first tape the top of the doors for safety. See Figure 10.

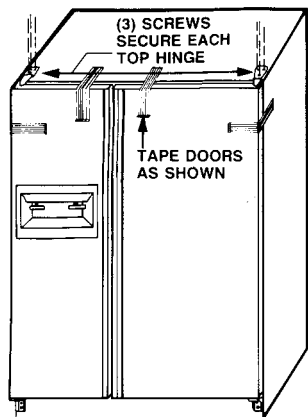

FIGURE 10

### CAUTION:

To Avoid The Risk Of Personal Injury Or Property Damage have two (2) people remove the door. One to hold the door and one to remove the safety tape, and help with the tools.

### WARNING:

To Avoid The Risk of Electrical Shock, Personal Injury or Death: DISCONNECT the power cord BEFORE removing the top hinge.

1. Remove the top hinge covers. See Figure 11.

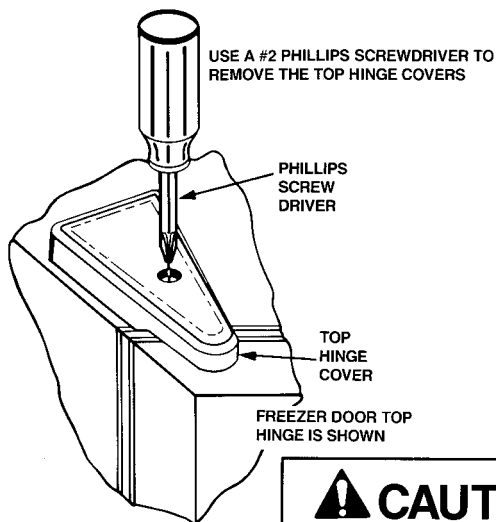

FIGURE 11

### CAUTION:

The power cord must not be connected.

3. Mark the location of the hinges with a pencil on the painted cabinet prior to removing hinge. See Figure 12.

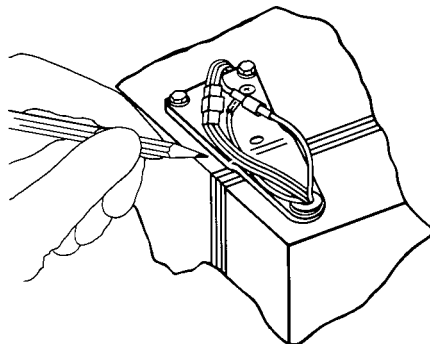

FIGURE 12

4. Disconnect top hinge freezer door wires. See Figure 13.

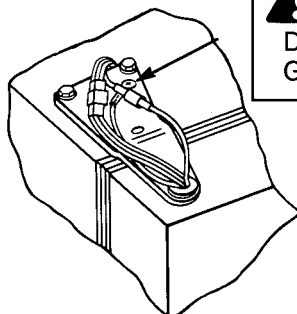

FIGURE 13

### WARNING:

Do Not Remove Green Ground Wire.

### WARNING:

It is critical that ground wires MUST be connected when the doors are reassembled.

# Door Assembly Removal (cont.)

5. First remove the toe grille then disconnect freezer door bottom hinge water line by loosening the 1/4" O.D. plastic tube union nut. See Figure 14.

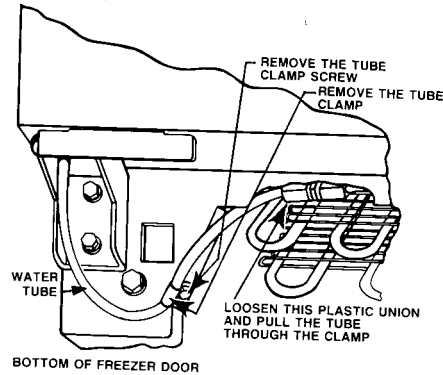

FIGURE 14

6. Remove the upper door hinges, (3) screws per upper hinge. See Figure 15.



## WARNING:

To Avoid The Risk Of Electrical Shock, Personal Injury or Death: DISCONNECT the power cord BEFORE removing the top hinge.



## WARNING:

Do Not Remove Green Ground Wire

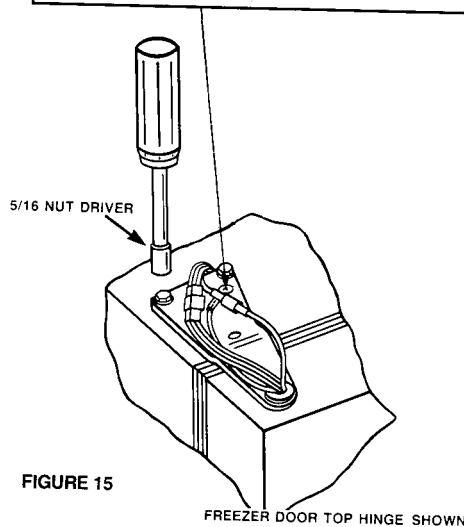

FIGURE 15

7. The freezer door water line will thread through the bottom hinge; lift the door off carefully. See Figure 16.

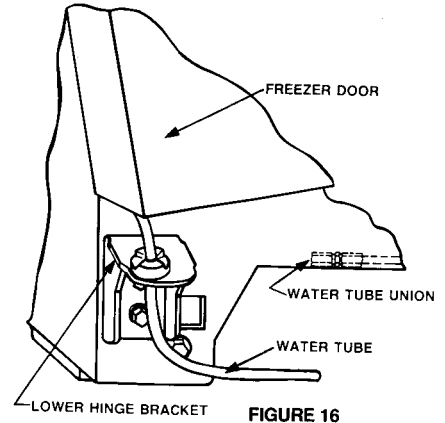

FIGURE 16

8. Remove the refrigerator door assemblies by lifting off the bottom hinge pins. Note: At this point the refrigerator may fit through the doorway. If not, proceed to step 9.
9. Mark around the lower hinge brackets. See Figure 17.

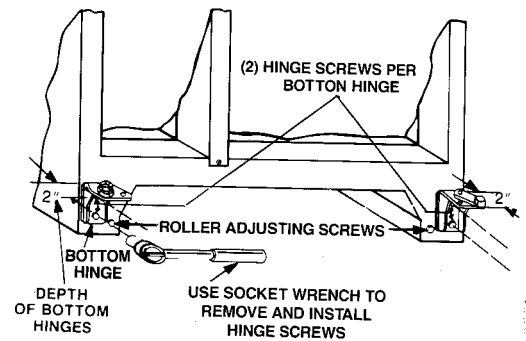

FIGURE 17

10. To reinstall the door assemblies assemble in reverse order.



## WARNING:

It is critical that ground wires MUST be connected when the doors are reassembled.

# Door Assembly Removal (cont.)

To Remove The Door Assemblies (Do NOT remove the door handles)

## Electronic Model

### **WARNING:**

To Avoid The Risk Of Personal Injury Or Death Disconnect The Power Cord Before Proceeding.

**Tools Needed:** Phillips Screwdriver,  $\frac{1}{16}$ " Nut Driver and Tightly Fitted Gloves.

1. Remove the toe grille.
2. Open refrigerator door to gain access to door closure screw. See Figure 18.

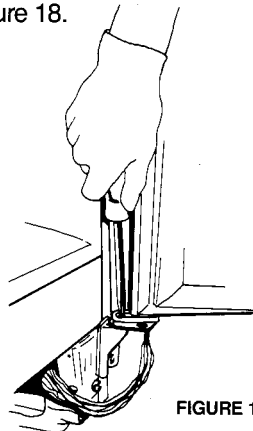

FIGURE 18

3. Unscrew bottom refrigerator door closure with a phillips screwdriver. See Figure 18.

Disconnect at connector. Push lock tab on underside of connector up and then pull loose. See Figure 19.

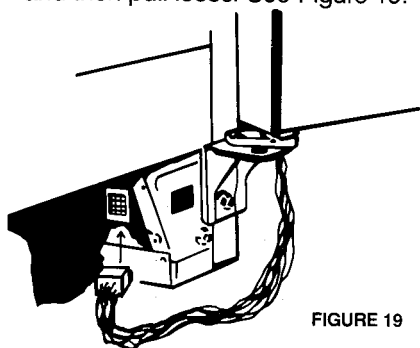

FIGURE 19

5. **CAUTION:**  
To Avoid The Risk Of Personal Injury Or Property Damage tape the top of the doors as shown in Figure 20.

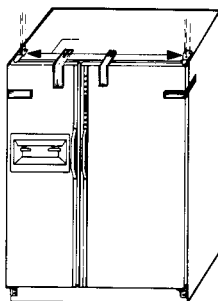

FIGURE 20

6. Remove the top hinge covers. See Figure 21.

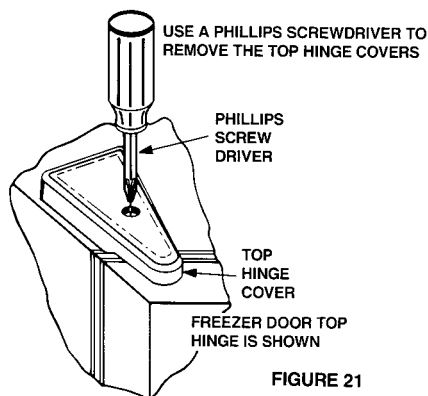

FIGURE 21

7. **WARNING:**  
To Avoid Risk Of Electrical Shock, Personal Injury Or Death, The Ground Wires Must Be Connected When The Doors Are Reassembled.

7. Mark the location of the hinges with a pencil on the painted cabinet prior to removing hinge. See Figure 22.

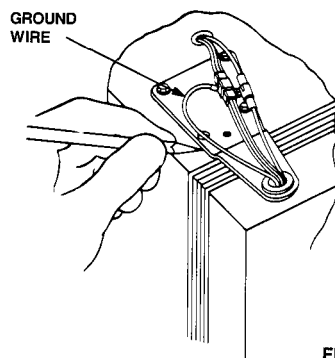

FIGURE 22

# Door Assembly Removal (cont.)

- Disconnect top hinge door wires. See Figure 23.

**WARNING:**  
Do Not Remove Green Ground Wire.

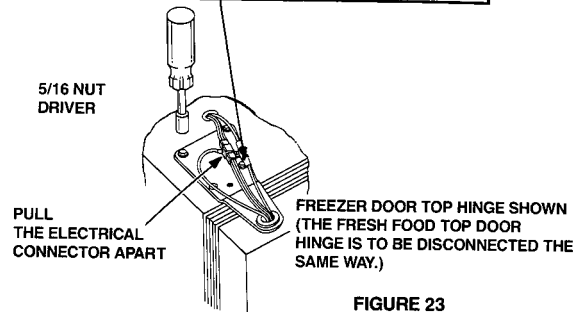

FIGURE 23

- Disconnect freezer door bottom hinge water line by loosening the 1/4" O.D. plastic tube union nut. See Figure 24.

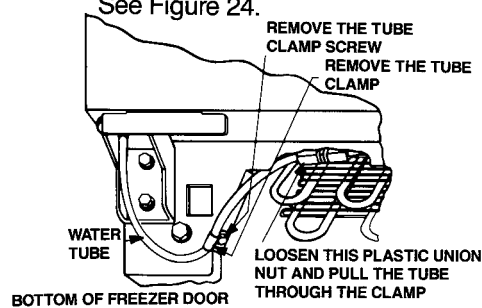

FIGURE 24

- Remove the upper door hinges, (3) three screws per upper hinge. See Figure 23.

**CAUTION:**  
To Avoid The Risk Of Personal Injury Or Property Damage have two people remove the door. One to hold the door and one to remove the safety tape, and help with the tools.

- Remove the tape from top of the freezer.
- The freezer door water line will thread through the bottom hinge; lift the door off carefully. See Figure 25.

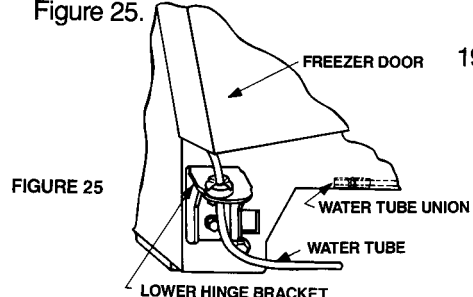

FIGURE 25

- Remove tape from top of refrigerator door.
- Lift refrigerator door up to pull pin up off the hinge.
- Thread wires through slot in door hinge. See Figure 26. Hinge pin and door closures stay attached to the door.

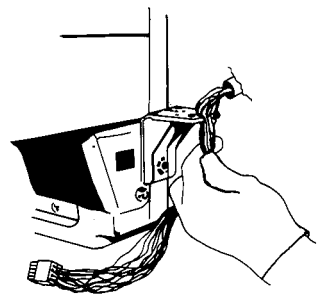

FIGURE 26

**CAUTION:**  
To Avoid The Risk Of Property Damage set refrigerator door down carefully to avoid damaging electrical wires.

**NOTE:** At this point, the refrigerator may fit through the doorway. If not, proceed to steps 17 and 18.

- Mark around the lower hinge brackets with a pencil. See Figure 27.

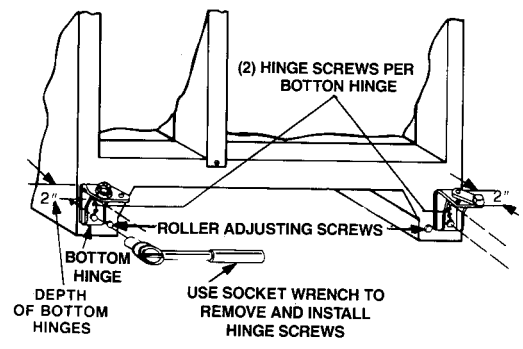

FIGURE 27

- Remove the lower hinge bracket screws. (2) screws per lower hinge.
- To reinstall the door assemblies assemble in reverse order.

# Leveling, Door Alignment and Placement

## Leveling

Install the unit on a solid floor that is strong enough to support the combined weight of the unit, approximately 320 lbs.; and the food, maximum of 625 lbs. with an approximate combined weight of 945 lbs.

The unit must be level to insure complete door closings and proper ice making. Improper leveling will cause water spills and uneven ice cube size.

The unit must be level from back to front. This allows doors to close firmly. If the floor is uneven from side to side, place thin metal plates under one of the

rear wheels. Adjust the front wheels or leveling feet to level the refrigerator. To raise, turn screw or leveling feet clockwise. To lower, turn counterclockwise. See Figure 29.

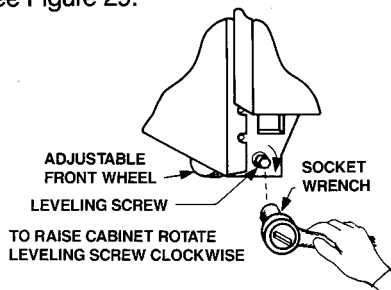

FIGURE 29

## Door Alignment

The doors on this refrigerator were aligned at the factory. Once the refrigerator is properly leveled, the doors will be aligned. If further adjustment is required, please follow the steps below.

1. Before checking alignment, open and close both doors to insure they are resting on the bottom bearings.
2. Check alignment of door at TOP CENTER. See Figure 30. If doors are aligned, go to step 4.
3. If doors are not aligned:
  - A. Lower the front wheel (turn the screw counterclockwise one turn at a time) on the side of the refrigerator which has the lower door. See Figure 29.
  - B. Open and close both doors.
  - C. Recheck alignment.
  - D. If doors are not aligned repeat steps A through C.
4. If one of the front wheels is not touching the floor (refrigerator will rock), lower that roller only enough to contact the floor.

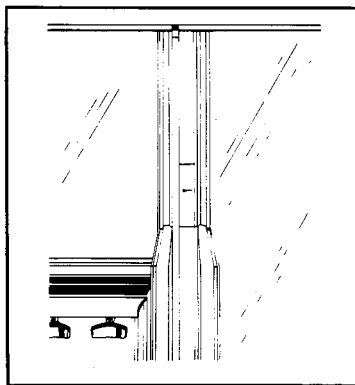

FIGURE 30

## Placement

Air to cool the condenser is drawn in the toe grille, at the bottom front, passes over the condenser, and is then exhausted through the same grille. Therefore, the unit can safely be enclosed completely at the top, back and sides for a built-in look. Do not block airflow through the toe grille at bottom front of unit.

**Placement of 20 Cu. Ft. Models**  
On some counter tops there is a 1" overhang. If this is the case, the front corners of the counter top must be trimmed off at a 45° angle for the

refrigerator and freezer door clearance. This also allows for a flush installation. See Figure 31.

A recessed electrical outlet installed on the back wall allows for built-in installation of your refrigerator. Suggested height requirement for recessed electrical outlet is 3 to 4 ft. from floor.

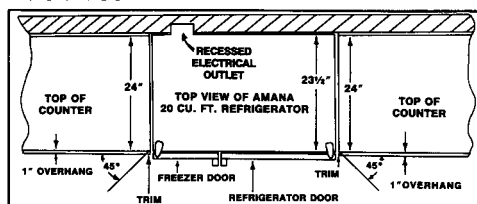

FIGURE 31

## CAUTION:

To Avoid Property Damage to soft vinyl flooring follow floor products manufacturer's recommendations when installing or moving the refrigerator.

# The Ice 'N Water™ Dispenser

## Automatic Night-Light

This is a feature that comes on automatically when it's dark. If you would prefer not to have the night-light feature, there is an on/off switch just above and between the ice and water dispensing bars. Push this switch in once to turn off the night-light.

The control panel light will also turn on automatically when dispensing ice or water if the manual switch is off.

## Night-Light Dispenser Bulb Replacement

Should the night-light bulb ever need to be replaced, it is located just above the water dispenser bar. Replace with a 120 volt, 6 watt bulb. Sylvania 6S6 bulb or order from your Amana Service Dept., part number M0360001.

## Do not add ice to ice bin.

Do not try to speed ice dispensing by adding cubes of ice that you may have purchased or made in some other way. The unit has been "matched" to the automatic ice maker and will not operate properly with different shaped or sized cubes.

## Water Dispenser

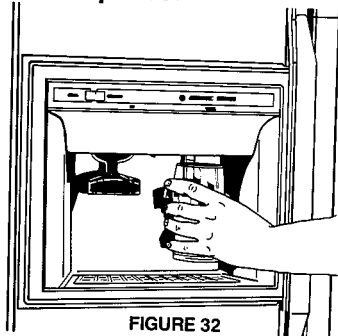

FIGURE 32

**To operate, press glass against the water dispenser bar. Releasing pressure shuts the water off.**

Some slight dripping may occur following dispensing of ice or water. If excessive, the spill should be wiped dry immediately. See Figure 33.

Do not pour water in spill shelf because it is not self-draining — pour it in the kitchen sink. The shelf and its grille should be cleaned regularly according to instructions on page 36.

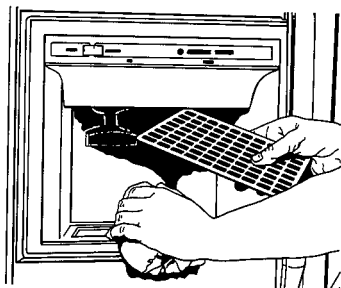

FIGURE 33

After the unit is connected to an active household cold water line, fill and throw out the first 10-14 eight-ounce glasses of water. This will cleanse the lines of impurities.

## Water taste and odor.

There are many variables which can affect the taste and odor properties of the water that is being dispensed from your Amana Ice 'N Water model such as:

1. Iron and other mineral deposits normally found in water.
2. Type of tubing (copper, galvanized, plastic, etc.) used in the household water supply system as well as the type of tubing used to connect your unit to your household water supply.
3. Water has been left standing unused in the storage reservoir and/or water supply line for a long length of time.

To minimize taste and odor problems, it is recommended that the following steps be taken:

1. Thoroughly rinse out the system after it has been connected to the household water supply. This can be accomplished by throwing away the first 10-14 eight-ounce glasses of water that are obtained from the unit.
2. If the water dispensing system has not been used for an extended time, the entire water reservoir and system should be flushed, as instructed above. This will ensure a fresh supply of water at all times.

If the above suggestions do not entirely eliminate an undesirable taste or odor condition in your water, your problem is most likely a water problem. It is recommended that you contact your local water treatment company for its specialized kind of help in solving your problem.

## How The Water Dispenser Works

The water reservoir is located in the refrigerator behind the hi-humidity compartment or crisper pan, depending on the model you have. **Important Note:** DO NOT REMOVE THE STYROFOAM OR PLASTIC COVER. The water line to the dispenser bar is routed in a special way to prevent freeze-ups. The water dispensing lever energizes the water line solenoid to add water to the water reservoir. See Figure 34.

# The Ice 'N Water™ Dispenser

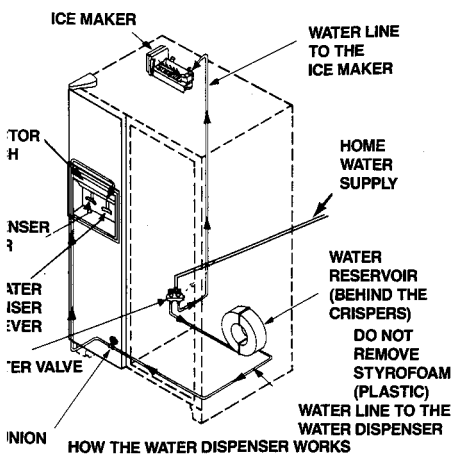

FIGURE 34

Water is forced by household water pressure through the tubing and out the dispenser.

Water remains in the water line to the dispenser, causing the first glass of water to be somewhat warmer than the following glasses.

## Bed & Crushed Ice Dispenser cept 19 cu. ft. model

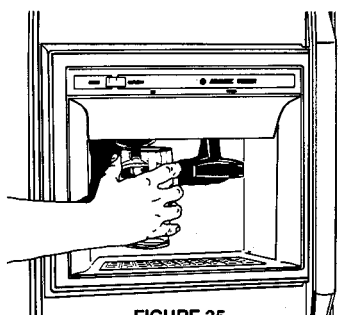

FIGURE 35

### Select Cube or Crush Mode.

To operate, apply pressure against the dispenser bar with a glass or other container. This activates the ice auger and wheel which automatically delivers bed or crushed ice to the glass. (cept 19 cubic foot refrigerators) **Release pressure on the dispenser bar before glass is full. Do not remove the glass until the last of the ice falls.**

**Normal Operation.** After installation, it will take 4 to 12 hours before the first vest of ice will occur. The time required will depend on the freezer temperature and the amount of food in the refrigerator and freezer section.

The ice storage bin takes about three or four days to fill, depending on how often you use it.

To help meet this demand, you can speed ice production by turning the freezer control to a colder setting. **For best overall operation of the unit, be sure to return the freezer control to its previous position as soon as possible.**

If you use very little ice over a period of a week or so — or if you use none at all for that period — the ice cubes may freeze into a solid mass and the unit will not dispense ice. You must then remove the ice bin (follow instructions on page 13) thaw the ice and throw it away.

**Overload.** If you hold the dispenser bar in the ON position for approximately 4-5 minutes, the dispenser motor may trip out on overload. This could occur if you were trying to fill a large container with ice. The overload will reset automatically in approximately 3 minutes, after which ice can again be dispensed.

**IMPORTANT! UNDER NO CIRCUMSTANCES SHOULD YOU USE AN ICE PICK OR SIMILAR SHARP INSTRUMENT TO BREAK THE ICE.** To do so could cause damage to the ice bin and/or ice auger.

**WARNING:**  
To Avoid Personal Injury **NEVER** put fingers or other objects into the ice dispenser opening.

### How the Ice Dispenser Works

**Safety.** All of the ice making and dispensing mechanisms are enclosed within their own compartment for safety and for maximum storage space in the freezer sections.

Whenever the freezer door is opened, the ice dispenser mechanism is interrupted. This prevents the dispensing of ice and also insures that you can safely service the ice bucket.

**WARNING:**  
To Avoid Personal or Property Damage **NEVER** attempt to operate the dispensing system with the door open.

Water is automatically measured into the ice maker. When the water freezes, a sensor initiates the ejector blades that dump the cubes into the U-shaped Harvester Bin, where they are held in storage for delivery. When you push the Dispenser Bar, a large auger gently, but firmly, moves cubes from the bin. See Figure 36.

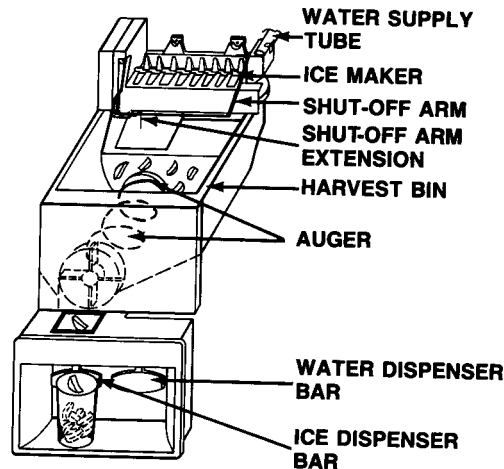

19 Cu. Ft. Model Only

FIGURE 36

**CAUTION:**

To Avoid Property Damage Do NOT Dispense Ice Directly Into Thin Glass, Fine China or Delicate Crystal.

Ice should not be dispensed directly into thin glasses, fine china or delicate crystal — they can crack or chip from the combined pressure of your hand pressing them against the cradle and ice dropping into the container.

**Cubed/Crushed Ice 'N Water™ Models Only.**

In the cube mode the auger turns the ice wheel in a counter clockwise direction bypassing the crusher blades and moving the cubes directly into the glass.

When the dispenser is in the crushed ice mode the auger turns in the clockwise direction forcing cubes into the crusher blades, dispensing crushed ice directly into the glass. See Figure 36A.

To help keep bits of ice from being sprayed beyond the glass, place the glass close to the ice chute.

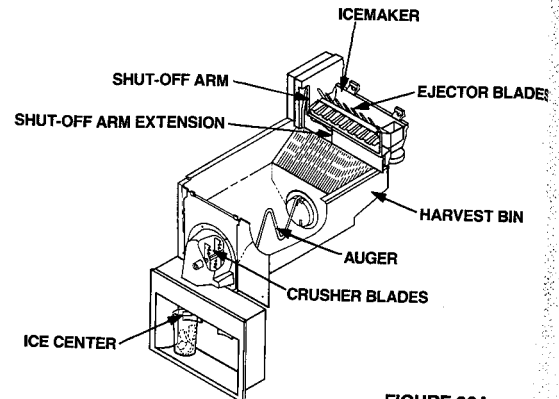

FIGURE 36A

**WARNING:**

To Avoid The Risk of Personal Injury NEVER attempt to manually clear the stall or jam by sticking your hand or any foreign object up the ice dispenser opening with the freezer door closed, with the harvest bin in place or with the unit plugged in.

In the case of a stall or jam, either in the cube or crushed mode, try dispensing in the opposite mode, several times if necessary. In most cases this will clear the dispenser. Do not manually attempt to clear the ice dispenser with the freezer door closed, with the harvest bin in place or with the unit plugged in. **TO DO SO COULD CAUSE SERIOUS PERSONAL INJURY.**

There may be a delay when switching between cube and crushed ice modes. **THIS IS NORMAL.** It takes a few seconds for cubes to be moved from the Harvest bin. **Crushed ice pieces will vary in size and shape.**

Sometimes a mound of snow will form on the door and/or ice chute. This condition is normal and usually occurs when you have dispensed crushed ice repeatedly. The snow will eventually evaporate.

**CAUTION:**

To guard against possible water damage. If the refrigerator will be unattended, raise the ice maker wire shut off arm and turn the water shut off valve for the refrigerator to OFF.

# The Ice 'N Water™ Dispenser

## Servicing The Ice Dispenser

Certain conditions will require you to service the ice maker and dispenser.

The unit has been designed so that you can do such servicing with a minimum of effort.

Cold dry air has to circulate in the freezer to maintain a safe freezing temperature. Thus, cubes stored in the bin will tend to evaporate and flow together if not used regularly.

### You should remove the bin and empty the contents:

- After the first few harvests of ice have been made by a newly installed unit. **THIS IS ESSENTIAL.** This allows all impurities in the line to be flushed out before use.
- If you are going to be gone for longer than a week, empty the storage bin of all ice cubes and raise the ice maker control arm. This will prevent the cubes from freezing into a mass around the ice auger.
- If the ice cubes become frozen to each other and around the ice auger.

**Ice maker control arm.** The wire control arm on the automatic ice maker has 2 functions:

1. **Normal Operation:** the wire arm is in the down position; ice will be made. See Figure 37.

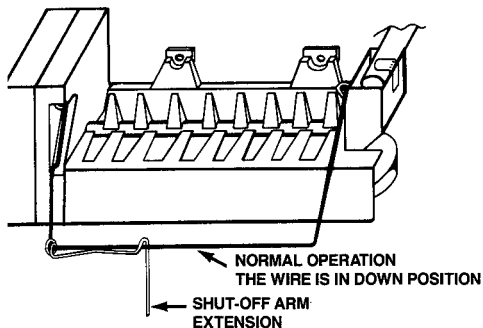

FIGURE 37

2. **Stopping Ice Production:** To stop ice production or to remove the ice bin: take hold of wire arm near black housing, and lift up. There will be an audible "click" when ice maker shuts off. The wire arm stays in the upper position. See Figure 38. As long as the arm is in this position, ice will not be made. The unit will continue to dispense cubes from the ice bin until all have been used.

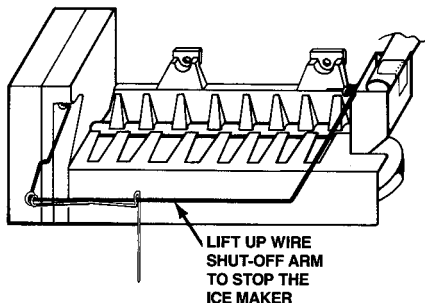

FIGURE 38

**To remove ice bin assembly:** Lift up the ice bin assembly  $\frac{1}{4}$ " , then pull out. See Figure 39.

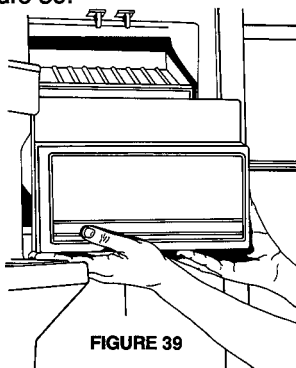
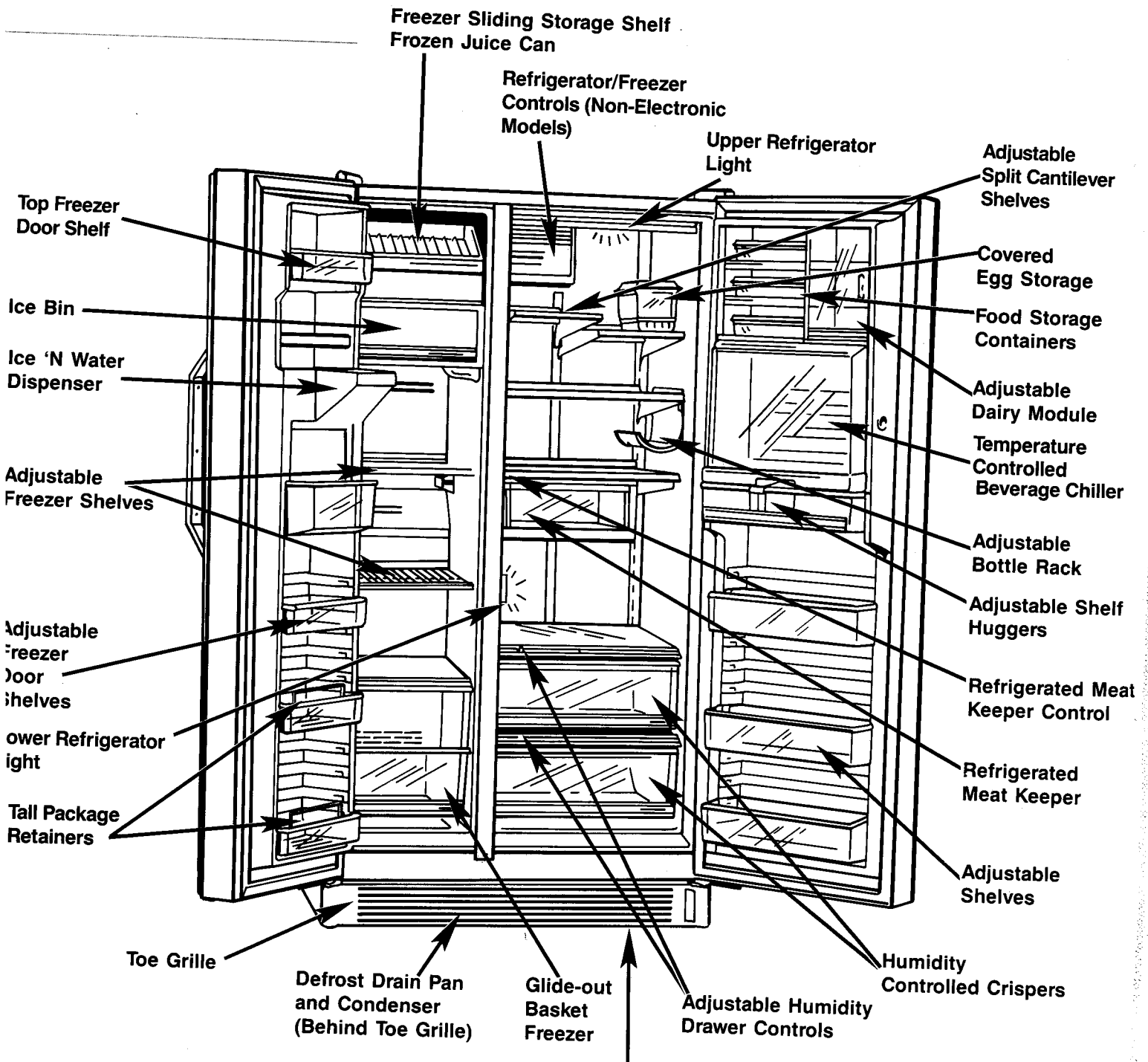

FIGURE 39

# General Features



Power switch (Located behind the toe grille in the center on the electronic model only)

**IMPORTANT NOTE:** Model shown is for a 27 cu. ft. refrigerator  
 FEATURES MAY VARY FROM MODEL TO MODEL. YOUR REFRIGERATOR MAY NOT HAVE ALL THE  
 FEATURES SHOWN.

# General Features

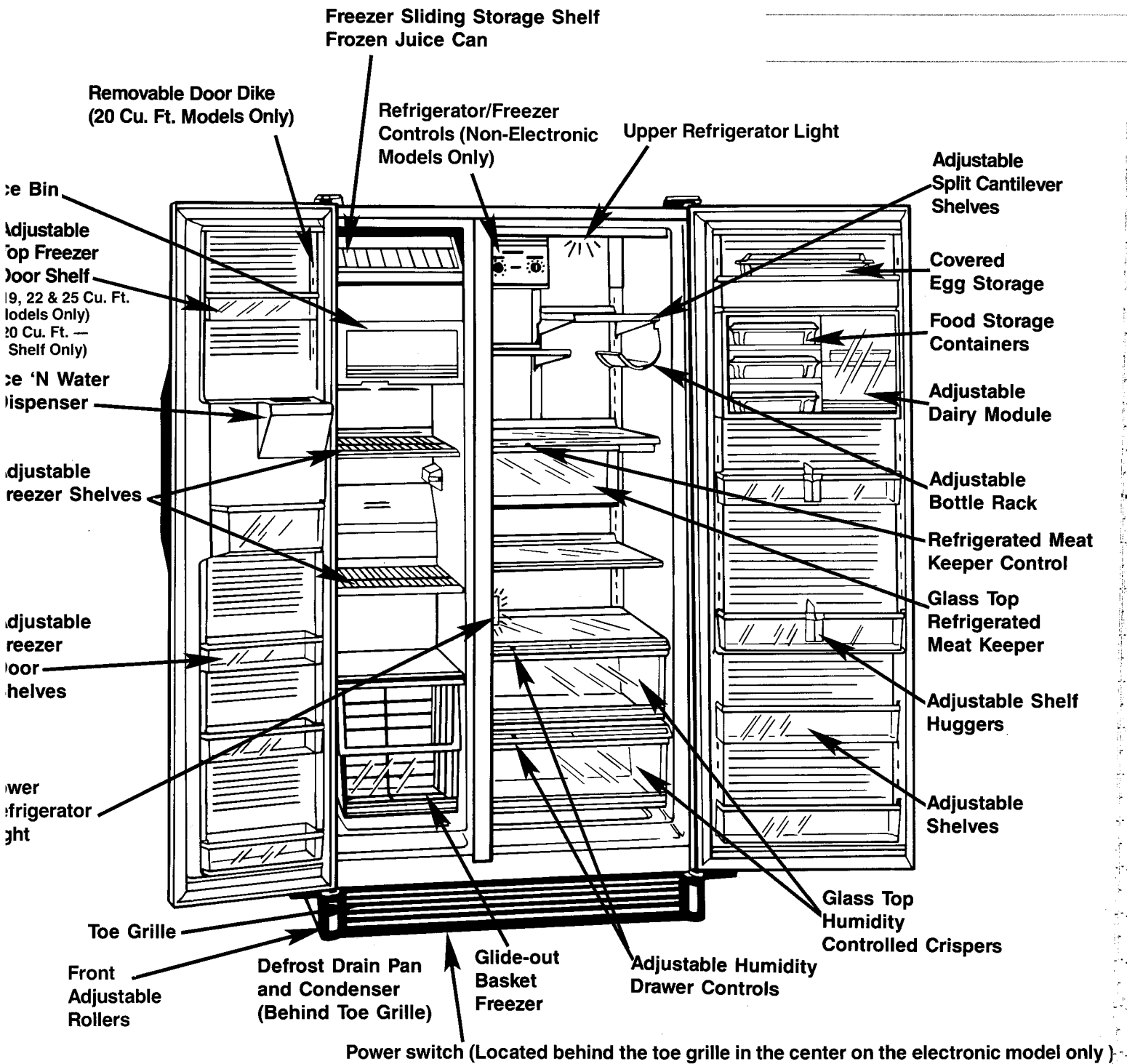

**IMPORTANT NOTE:** Model shown is for a 25 cu. ft. refrigerator  
 FEATURES MAY VARY FROM MODEL TO MODEL. YOUR REFRIGERATOR MAY NOT HAVE ALL THE  
 FEATURES SHOWN.

# Dimensions

## DIMENSIONS

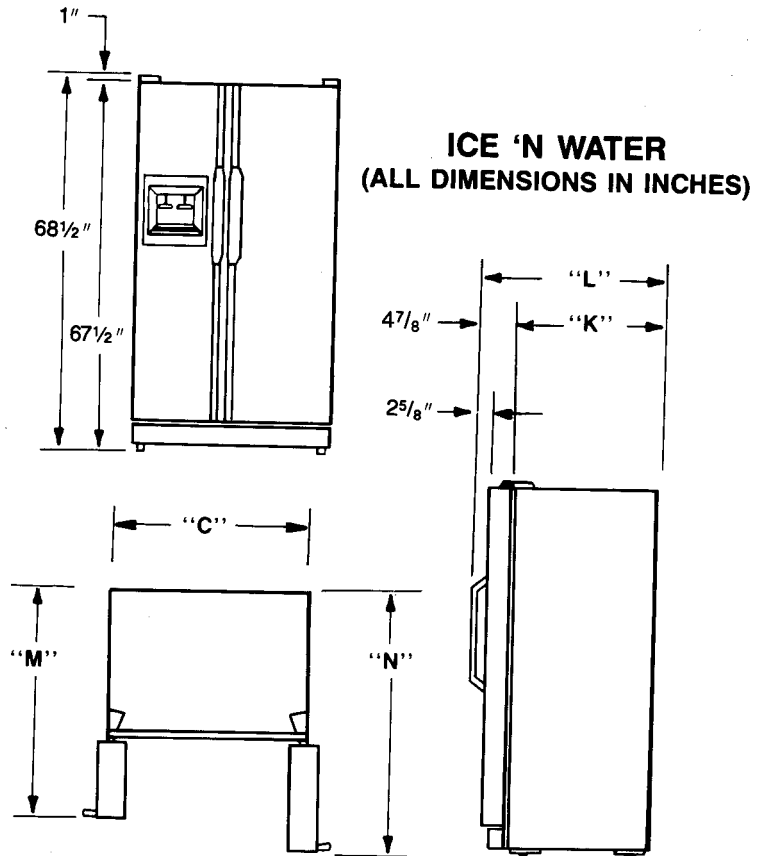

MODEL	"C" CABINET WIDTH	"K" DEPTH DOOR REMOVED	"L" DEPTH INCL. HANDLE	"M" FRZ DOOR OPEN 90°	"N" REF DOOR OPEN 90°
19*	32	27	31 <sup>1</sup> / <sub>8</sub>	43	44 <sup>7</sup> / <sub>8</sub>
20*	35 <sup>3</sup> / <sub>4</sub>	23 <sup>1</sup> / <sub>2</sub>	28 <sup>3</sup> / <sub>8</sub>	39 <sup>5</sup> / <sub>8</sub>	45 <sup>1</sup> / <sub>4</sub>
22*	35 <sup>3</sup> / <sub>4</sub>	26	30 <sup>7</sup> / <sub>8</sub>	42 <sup>1</sup> / <sub>8</sub>	47 <sup>3</sup> / <sub>4</sub>
25*	35 <sup>3</sup> / <sub>4</sub>	28 <sup>3</sup> / <sub>4</sub>	33 <sup>5</sup> / <sub>8</sub>	44 <sup>7</sup> / <sub>8</sub>	50 <sup>1</sup> / <sub>2</sub>
27**	35 <sup>3</sup> / <sub>4</sub>	28 <sup>3</sup> / <sub>4</sub>	35 <sup>3</sup> / <sub>4</sub>	44 <sup>7</sup> / <sub>8</sub>	50 <sup>1</sup> / <sub>2</sub>

\*Must be installed 2<sup>3</sup>/<sub>4</sub>" from side walls for 90° door opening.  
 \*\*Must be installed 4<sup>7</sup>/<sub>8</sub>" from side walls for 90° door opening.  
 Allow 1/4" on top and sides for ease of installation.

# Setting the Controls

## Freezer Control

This is the main control located on the upper back wall of the fresh food section. Non-electronic models only. See Figure 43. If it is turned OFF, neither the Freezer nor the Refrigerator will cool. All of the electrical circuits remain energized except for the compressor and fan motors. The control has seven settings, from "1" (the warmest) to "7" (the coldest). Start by setting the dial on "4". Load food in freezer. Allow 24 hours for the freezer to cool after the unit is installed, before checking food temperatures.

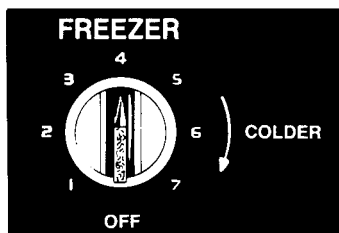

FIGURE 43

**Check Food Temperature** as instructed on page 18. **Adjust the control as needed one number at a time.** The best temperature for frozen food storage is in the 0° to 2°F range.

## Temp-Assure™ Thermostatic Refrigerator Control

This control, located on the upper back wall of the fresh food section, operates independently of the freezer control. Non-electronic models only. See Figure 44. A hidden thermostatic sensor measures refrigerator air temperature constantly, and automatically lets in more cold air if temperature rises as little as 1½°F from your setting.

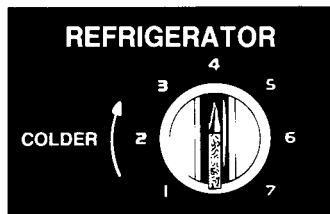

FIGURE 44

The control has seven settings, from "1" (the warmest) to "7" (the coldest). The best food storage temperature is in the 38° to 40°F range. Start by setting the dial on 4. Load food in the refrigerator. Place a glass of water on the middle shelf of the refrigerator section, making sure that air can flow around it. (This will be used later to check food temperature.) After the unit is installed, allow 24 hours for the refrigerator to cool. Check food temperature as instructed on page 18. (Adjust the control as needed, one number at a time.)

## Temperature Controlled Beverage Chiller Control

A rotary dial control, located on the left inner wall of the refrigerator section, allows you to adjust the amount of freezer air that circulates into the beverage chiller. See Figure 45. This keeps beverages up to 5 degrees F colder than the rest of the refrigerator. Turn the wheel clockwise for the coldest temperatures and counter clockwise for warmer temperatures.

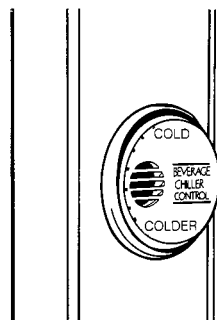

FIGURE 45

On the outside wall of the refrigerator door is the air inlet which allows freezer air to pass to the beverage chiller. See Figure 46. The additional cold air can affect the refrigerator compartment temperature, so the Temp-Assure™ Thermostatic Control may require adjustment after the beverage chiller temperature has been set.

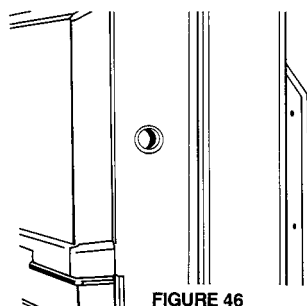

FIGURE 46

# Checking The Controls

## Checking Food Temperature

Twenty-four hours after the unit is installed, check the food temperature in the refrigerator and freezer sections. Use a quality thermometer that can register below-zero temperatures.

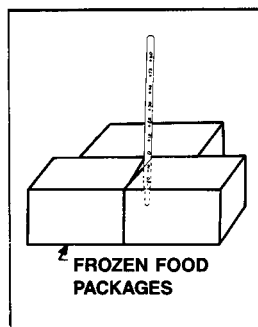

FIGURE 47

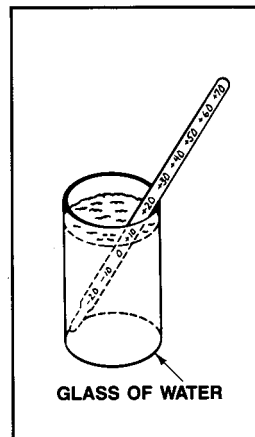

FIGURE 48

**FREEZER:** Place the thermometer in the center of the freezer, surrounded by frozen packages. See Figure 47. Wait 5 to 8 hours, then check the reading. If temperature is not within 0° to +2°F, adjust control as needed, one number at a time and check the temperature again after 4 to 6 hours.

**REFRIGERATOR:** Place the thermometer in a glass of water and place the glass in the middle of the refrigerator section. See Figure 48. Be sure air can flow around it. Wait 3 to 4 hours, check the temperature and adjust the control one number at a time as needed to within the 38° to 40°F range. Wait 3 to 4 hours and check the temperature again.

## Energy Saver Control

The 2-Position Energy Saver Control lets you save energy by adjusting refrigerator operation to the humidity level in your house. See Figure 49. During hot, humid weather, any refrigerator/freezer will form moisture around the doors, similar to the way condensate forms on a glass of ice water. The cabinet has special heaters to minimize this condensation. The Energy Saver Control lets you control the amount of heat the heaters are giving off.

**The upper position** is for periods of high humidity.

**The lower position** turns the heaters off for maximum energy savings. Use for periods of low humidity.

A minimum amount of condensation is normal. During extreme high humidity, condensate may also form on the cabinet sides and doors. This is normal and will disappear when climatic conditions return to normal.

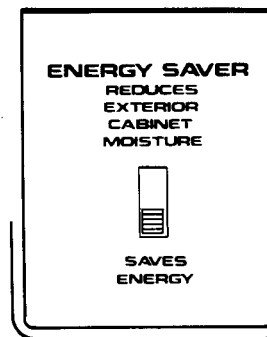

FIGURE 49

# Touchmatic™ Electronic Controls

The Amana Touchmatic Electronic Center gives you the freedom of controlling your refrigerator from a simple-to-operate control panel located above the door handle on the exterior of your refrigerator.

The Touchmatic Control Center alerts you when a door is open, when the freezer/refrigerator temperature is too high and even when you need to clean the condenser coil, plus much more.

To ensure that your new Amana Touchmatic Electronic Refrigerator operates correctly follow the simple-to-operate instructions on the following pages.

## BEFORE YOU GET STARTED . . . . .

When your refrigerator is first plugged in, the temperature indicator lights will blink. Press the START pad (the ✱) or ALARM OFF pad.

## POWER SWITCH

Located behind the toe grille in the center is a switch. This switch must be in the on position before you proceed any further.

**NOTE:** The alarm may go off in (2) two hours and the High Temp indicator light flash, if the refrigerator and freezer have not been cooled to the proper temperature. Deactivate alarm by pressing the ALARM OFF pad.

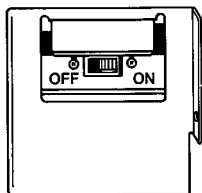

POWER SWITCH



OR



## START pad

To activate the control panel first press the START pad (the ✱). This will be referred to as the START pad in the remaining sections.

Pressing this pad will:

1. Turn the temperature indicator lights on.
2. Allow you to use any of the other pads on the control panel. If you do not press the START pad, none of the pads will operate except the ALARM OFF pad.



**NOTE:** Once activated, the pads will remain programmable for at least 10 minutes.

## OPTIONAL ENTRY TONE

Your refrigerator is designed to give you the option of a 'beep' signal whenever a pad is pressed. This signal lets you know the control has 'read' and accepted your command. The entry signal has been pre-set on your control panel and will 'beep' when a pad is pushed. If you wish to cancel the 'beep' signal follow the directions below.

### To Cancel The Optional Entry Tone:

1. Press and hold the START pad (the ✱) for approximately (3) three to (5) five seconds. Three (3) short beeps will sound indicating the instructions have been registered. To reactivate the entry signal, repeat the above process.

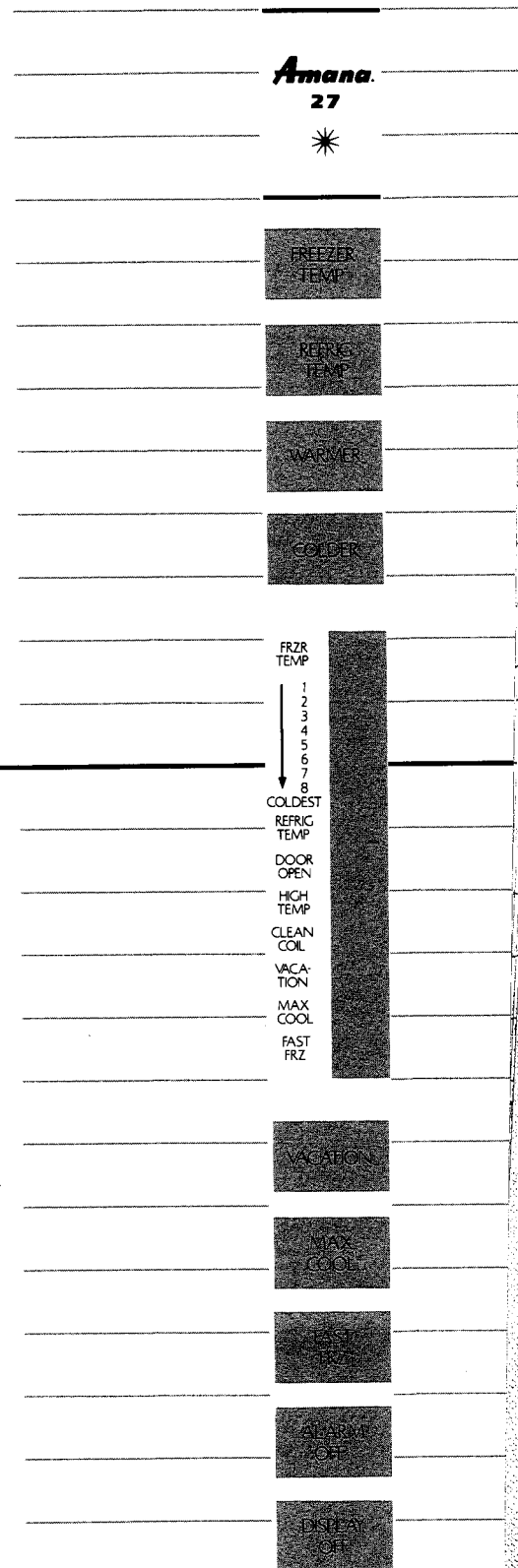

# Touchmatic™ Electronic Controls (cont.)

## TEMP-ASSURE™ THERMOSTATIC REFRIGERATOR CONTROL

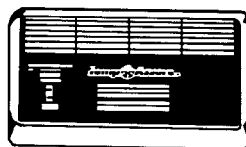

An Electronic thermostatic sensor measures refrigerator air temperatures constantly and automatically lets in more cold air if temperature rises as little as 1½°F from your setting.

## PROGRAMMING YOUR REFRIGERATOR

### TEMPERATURE SETTINGS

With the Amana Touchmatic Electronic Control, you can precisely control the temperature in the refrigerator and freezer sections of the refrigerator even opening the doors. The freezer temperature and the refrigerator temperature may be changed independent of one another. The temperature of each can be set at

one of nine temperature levels. One (1) being the warmest and nine (9) the coldest. When changing the temperature, the temperature indicator lights will be on. The indicator lights will tell you whether the freezer or refrigerator temperature is being changed and what level the temperature is currently at.

### To Set Or Change The Temperature In The Refrigerator

The control has nine settings, from '1' (the warmest) to '9' (the coldest). The best food storage temperature is in the 38° to 40° range. Start by programming your controls as follows:

1. Press the START pad (the \*).
2. Press the REFRIG TEMP pad. This tells the control panel you want to set the temperature in the refrigerator.

3. The starting temperature setting in the refrigerator is setting number 5.
4. Press the WARMER or COLDER pad to raise or lower the temperature setting one level at a time. Continue to hold the WARMER pad or COLDER pad down to raise or lower the temperature more than one level at a time.

**Amana.**

**27**



+



+



OR



Raises or Lowers  
Temperature Setting  
One Level At A Time

**Amana.**

**27**



+



+



.....  
Continue to Press Down

Lowers Temperature  
= Setting More Than  
One Level At A Time

**Amana.**

**27**



+



+



.....  
Continue to Press Down

Raises Temperature  
= Setting More Than  
One Level At A Time

Load food in the refrigerator. Place a thermometer in a glass of water in the middle of the refrigerator section, making sure that air can flow around it. (This will be used later to check food

temperature.) After the unit is installed, allow 24 hours for the refrigerator to cool. Check food temperature as instructed on page 18. Adjust the control as needed, one number at a time.

**Amana.**  
**27**



# Touchmatic™ Electronic Controls (cont.)

## To Set Or Change The Temperature In The Freezer

The control has nine settings, from '1' (the warmest) to '9' (the coldest). The best food storage temperature is in the 0° to +2°F range. Start by programming your controls as follows:

1. Press the START pad (the ✱)
2. Press the FREEZER TEMP pad.  
This tells the control panel you want to set the temperature in the freezer.

3. The starting temperature setting in the freezer is setting number 5.
4. Press the WARMER pad or COLDER pad to raise or lower the temperature setting one level at a time. Continue to hold the WARMER pad or COLDER pad down to raise or lower the temperature more than one level at a time.

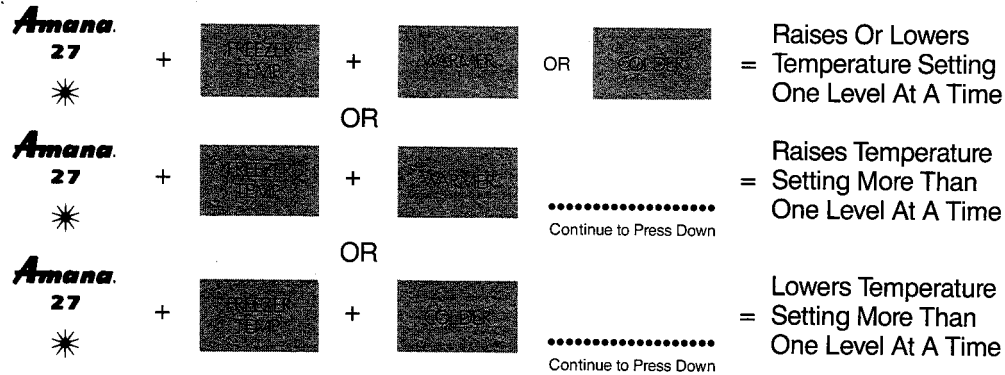

Load food in the freezer. Place a thermometer between the frozen food in the middle of the freezer section. (This will be used later to check food temperature.)

After the unit is installed, allow 24 hours for the freezer to cool. Check food temperature as instructed on page 18. Adjust the control as needed, one number at a time.

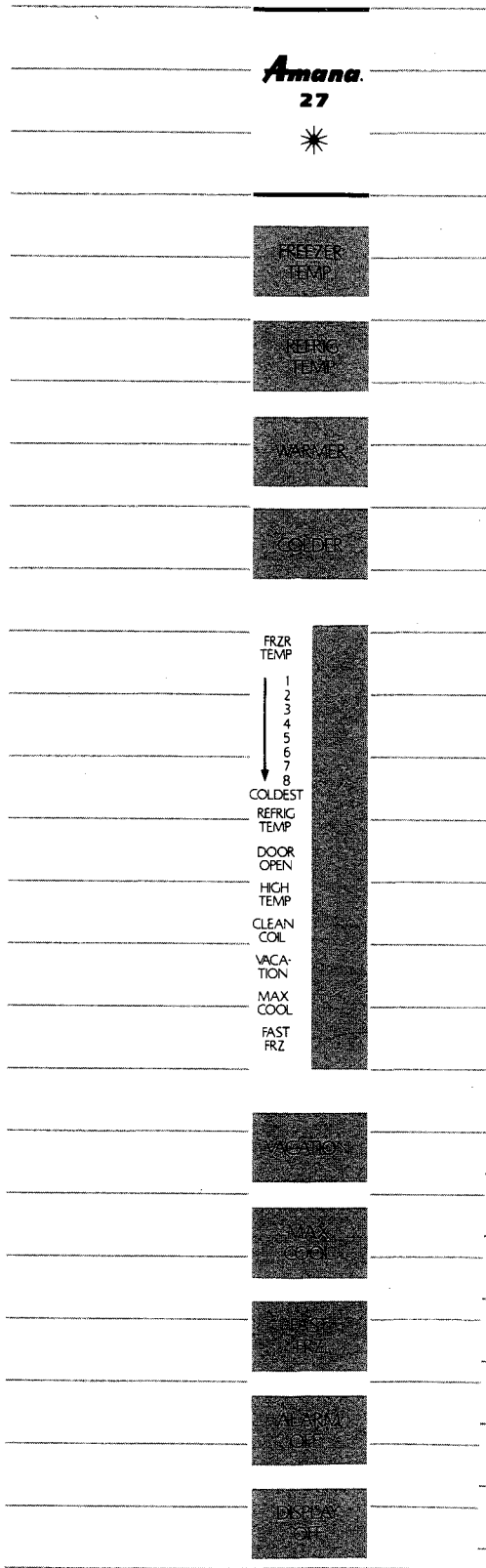

# Touchmatic™ Electronic Controls (cont.)

**Amana**

**27**

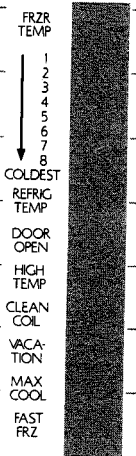

## VACATION MODE

The Vacation Mode is ideal for when you will be away from your home for an extended amount of time, but still wish to preserve the food in your refrigerator.

During this mode the refrigerator will defrost less often, saving energy and money.

### To Start The VACATION Mode

1. Press the START pad (the \*).
2. Press the VACATION pad. The vacation indicator light will come on acknowledging your command.

**Amana**

**27**



+



=

Vacation Indicator Light Will Come On Indicating Vacation Mode Is Now On\*\*

### To Cancel The VACATION Mode

1. Press the START pad (the \*).
2. Press the VACATION pad again OR
3. Open either the refrigerator or freezer door.

**Amana**

**27**



+



OR

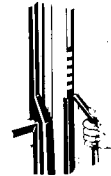

Open Door

=

Cancel Vacation Mode

## **CAUTION:**

To Avoid The Risk Of Property Damage see pages 13 and 34 for important ice maker instructions during non-use periods.

## MAX COOL MODE

During this mode, the refrigerator temperature is reduced to the coldest set point for ten (10) hours. Ideal if you like colder drinks or have added a lot of warm food.

After the ten (10) hour time period the refrigerator temperature will return to the previous temperature setting.

### To Start the MAX COOL Mode

1. Press the START pad (the \*).
2. Press the MAX COOL pad. The MAX COOL indicator light will come on acknowledging your command.

**Amana**

**27**



+



=

Indicator Light Will Come On Indicating The Control Panel Has Heard Your Command

### To Cancel The MAX COOL Mode

1. Press the START pad (the \*).
2. Press the MAX COOL pad again.

**Amana**

**27**



+



OR

Will automatically return to previous temperature setting after (10) ten hours.

=

Cancel MAX COOL Mode

# Touchmatic™ Electronic Controls (cont.)

## FAST FREEZE MODE

This mode reduces the freezer temperature to the coldest set point for 24 hours. Ideal for freezing large amounts of food

quickly. After the 24 hour period the freezer will automatically return to the previous temperature setting.

### To Start The FAST FREEZE Mode

1. Press the START pad (the \*).
2. Press the FAST FRZ pad. The FAST FREEZE indicator light will come on acknowledging your command.

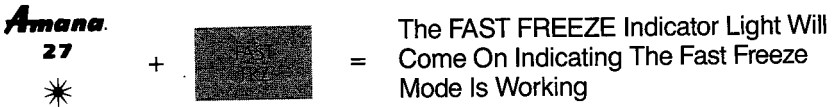

### To Cancel The FAST FREEZE Mode

1. Press the START pad (the \*).
2. Press the FAST FRZ pad again.

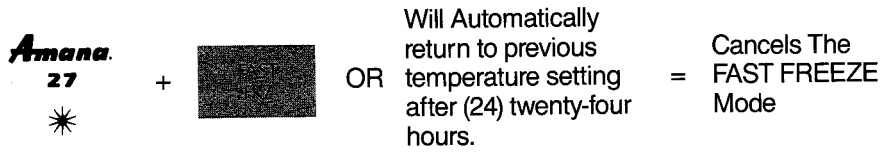

### To Cancel The Temperature Display Lights

1. Press the START pad (the \*).
2. Press the DISPLAY OFF pad.

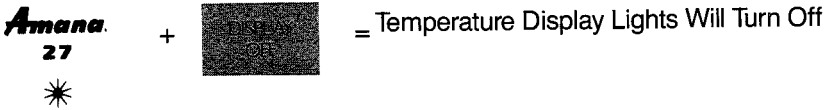

### To Reactivate The Temperature Display Lights

1. Press any of the top (5) pads.

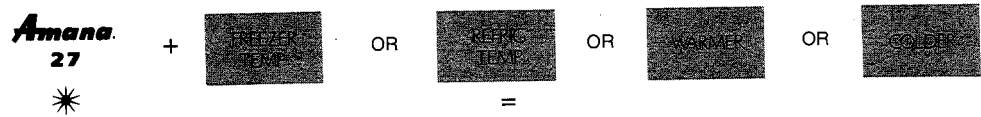

Will Activate The Temperature Display Lights

## SIGNALS TO ALERT YOU

Audio and visual signals have been specially designed into your refrigerator to quickly alert you to conditions you might not be aware of if you owned a conventional refrigerator.

### DOOR OPEN ALARM

The indicator light will come on whenever either door is open. If either door is open continuously for three (3) minutes, the indicator light will blink and an alarm will sound.

### To Discontinue The Door Open Alarm

1. Press ALARM OFF or close the door(s).

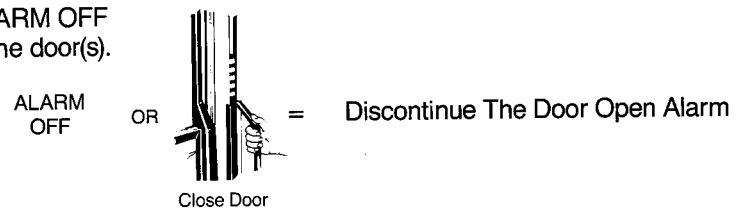

**Amana**  
27

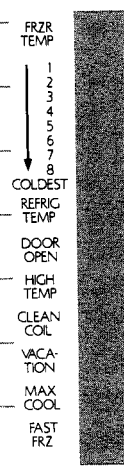

# Touchmatic™ Electronic Controls (cont.)

**Amana**  
27

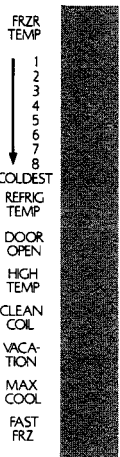

## To Cancel The Door Open Audio Alarm PERMANENTLY

1. Press the START pad (the \*).
2. Hold the ALARM OFF pad for three (3) to five (5) seconds. Three (3) short beeps will sound indicating the instructions have been registered.

**Amana**  
27



+



.....  
Press Down for 3-5 seconds

= Audio Alarm Is Deactivated

## To Reactivate The Door Open Audio Alarm

1. Press the START pad (the \*).
2. Hold the ALARM OFF pad for three (3) to five (5) seconds. Three (3) short beeps will sound indicating the instructions have been registered.

**Amana**  
27



+



.....  
Press Down for 3-5 seconds

= Audio Alarm Is Reactivated

## HIGH TEMPERATURE ALARM

The indicator light will come on if the freezer and/or refrigerator temperature gets excessively warm for an extended period of time. The FREEZER TEMP and/or the REFRIGERATOR TEMP

indicator light will blink to indicate which section is too warm. An alarm will also sound. Check for possible food spoilage.

## To Discontinue The High Temperature Alarm

1. Press the ALARM OFF pad. The audio alarm will also discontinue if the proper temperature is regained in the refrigerator and/or freezer sections. Check for possible food spoilage.  
**NOTE:** You must press ALARM OFF to clear the high temperature indicator light.



= Discontinues The High Temp Alarm

## CLEAN CONDENSER COIL INDICATOR

The indicator light alarm will come on, without an audio alarm, every three (3) months to remind you to clean the condenser coil. The refrigerator will run more

efficiently when the coil is clean. For information on how to clean your condenser coil, refer to page 36.

## To Discontinue The Clean Condenser Alarm

The light will automatically cancel in 72 hours or you can turn it off prior to that as follows:

1. Press The ALARM OFF pad.

ALARM  
OFF

=

To Cancel Clean Condenser  
Coil Alarm

# Refrigerator Features (All Models)

## Refrigerated Meat Keeper Control

The Refrigerated Meat Keeper features a drawer inside a wrapper or sleeve. A control, located in the front trim, allows you to adjust the amount of freezer air that circulates between the drawer and sleeve to keep meat up to 5°F colder than the rest of the refrigerator. See Figure 50. Slide the control to the left for the coldest temperatures and to the right for warmer temperatures. The additional cold air can affect the refrigerator compartment temperature, so the Temp-Assure™ thermostatic control may require adjustment after the Meat Keeper temperature has been set.

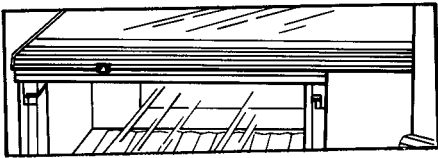

FIGURE 50

## Refrigerated Meat Keeper Drawer

The Refrigerated Meat Keeper must be installed with its cold air supply tube covering the air inlet port completely. To ensure proper alignment, only insert the upper hooks of the shelf into the 9th, 10th, 11th or 12th track slots from the top. See Figure 51. Otherwise food will freeze below the uncovered air supply hole, located in the back left side wall.

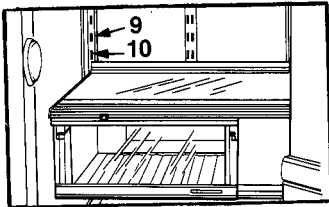

FIGURE 51

## Adjustable Cantilever Glass Shelves

These shelves attach to metal tracks at the back of the interior. See Figure 52. To remove the Cantilever Shelves, follow the instructions below.

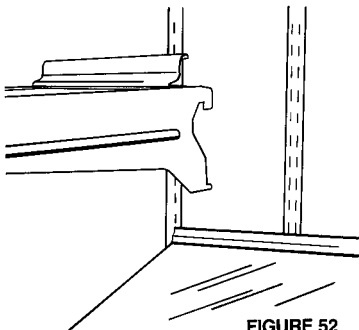

FIGURE 52

1. Tap upwards at rear of shelf near the tracks to loosen shelf hooks. See Figure 53.

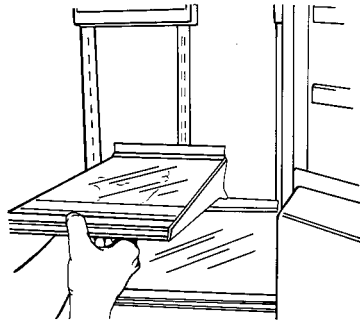

FIGURE 53

2. Lift shelf and pull out. See Figure 54. To install, tilt shelf and engage upper hooks in desired track slots. Lower shelf front and tap downwards near the tracks until shelf hooks are securely seated and shelf is level.



## CAUTION:

To Avoid The Risk Of Property Damage - Test shelf installation by applying pressure to front edge of shelf.

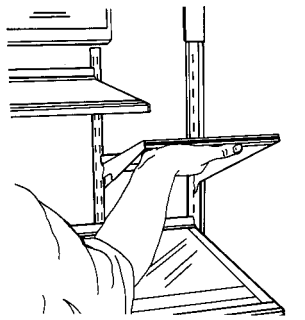

FIGURE 54

# Refrigerator Features (All Models cont.)

## Refrigerated Meat Keeper and Humidity Controlled Crisper Drawer Removal

Both the Refrigerated Meat Keeper and Humidity Controlled Crisper Drawer may be removed for easy cleaning by following these easy to follow instructions.

1. Pull the drawer three quarters of the way out. See Figure 55.

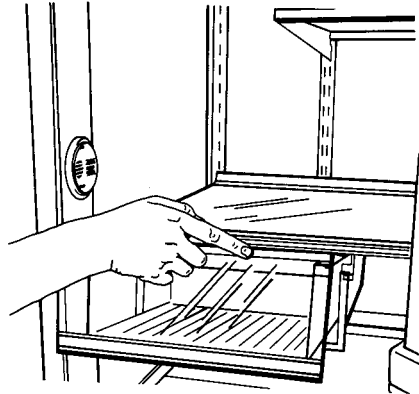

FIGURE 55

2. Lift up slightly to release notches in the grooves. See Figure 56.

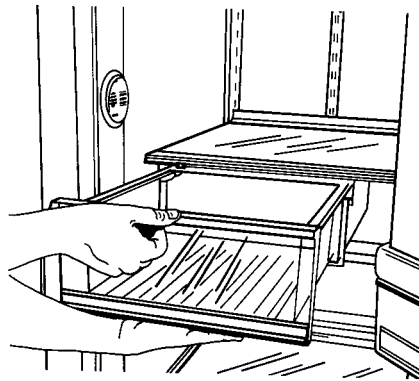

FIGURE 56

3. Pull drawer out the rest of the way. See Figure 57.

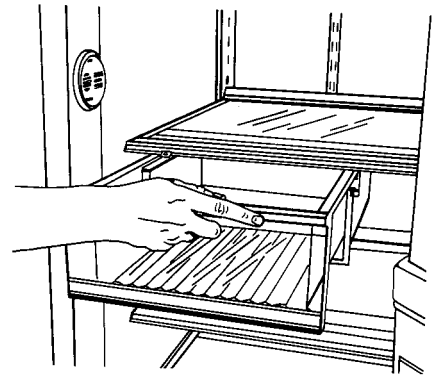

FIGURE 57

## Humidity Controlled Crisper Drawers

These drawers are for storage of fresh fruits and vegetables. It is normal for moisture to accumulate inside. See Figure 58.

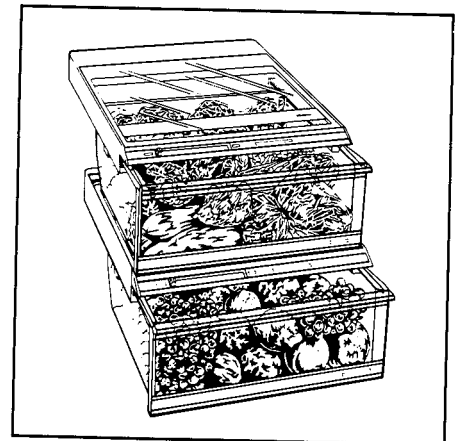

FIGURE 58

# Refrigerator Features (cont.)

Crisper Drawers can be pulled out fully, even when door is opened at a 90° angle. At a 90° door opening the two lower door shelves must be removed to completely take out the crisper. See Figure 59.

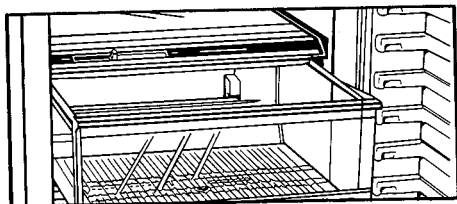

FIGURE 59

Hi-Humidity Drawers have a control to regulate humidity inside. Set high humidity for leafy vegetables such as cabbage and lettuce, and set low humidity for produce with skins such as apples and tomatoes. On models with humidity control, slide control to the left for high humidity and to the right for low humidity. See Figure 60.

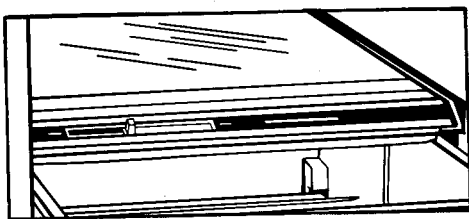

FIGURE 60

## Bottle Rack

This rack hangs from a shelf and holds a large bottle within easy reach. It is shipped inside a crisper drawer. To install, hook tabs on flat portion of rack over the side metal frame of any shelf. The shelf may have to be tilted up or removed temporarily. Be sure bottle cap is on tightly before placing a bottle in the rack. See Figure 81.

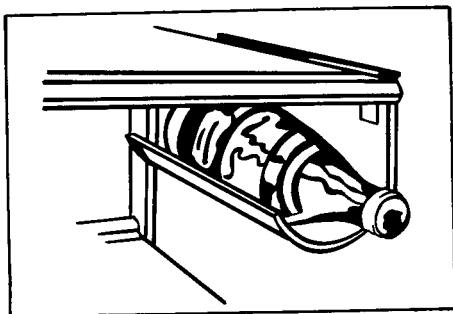

FIGURE 61

## If Light Bulb Needs Replacing:

- Unplug unit from wall outlet to avoid electrical shock. A pair of gloves should be worn as a precaution against broken glass.

## Refrigerator Compartment

1. Unscrew the light bulb(s) located on the front upper wall of the refrigerator compartment by turning counterclockwise.
2. Replace with a 40 watt G.E. or Westinghouse #40A15/1, Sylvania #40A15 or order from your Amana Service Dept., part number A0282803.

## Freezer Compartment

To remove the light bulb located on the right wall of the cavity, directly below the ice bucket of the upper freezer compartment, follow the directions below:

1. Remove the ice maker drawer.
2. Remove the protective shield by unscrewing the nut with a 1/4" drive or socket wrench.
3. Unscrew the light bulb counterclockwise.
4. Replace with a 40 watt G.E. or Westinghouse #40A15/1, Sylvania #40A15 or order from your Amana Service Dept., part number A0282803.

## Dispenser Light Bulb

Should the light bulb ever need to be replaced, it is located just above the water dispenser bar.

1. Unscrew the bulb counterclockwise.
2. Replace with a 120 volt, 6 watt Sylvania 6S6 bulb or order from your Amana Service Dept., part number M0360001.

# Refrigerator Features (27 Cu. Ft. Only)

## Stor-Mor® Door (27 Cu. Ft. Model Refrigerator)

**Egg Storage.** A removable take-to-counter egg bucket stores eggs in a see-thru covered container. See Figure 62. To clean, handwash in warm soapy water.

**Egg Storage.** A removable take-to-counter egg bucket stores eggs in a see-thru covered container. See Figure 62. To clean, handwash in warm soapy water.

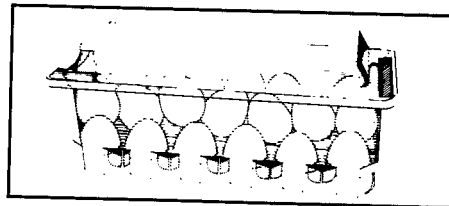

FIGURE 62

**Dairy Storage.** Store butter and cheese in an adjustable dairy module complete with three food storage containers and three dairy compartments with sliding door. See Figure 63.

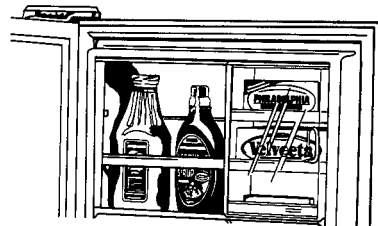

FIGURE 63

## Dairy Storage Door

The sliding door is removable for easy cleaning. Grasp the bottom of door and gently lift up and out. The door will bend slightly to allow removal from track. See Figure 64.

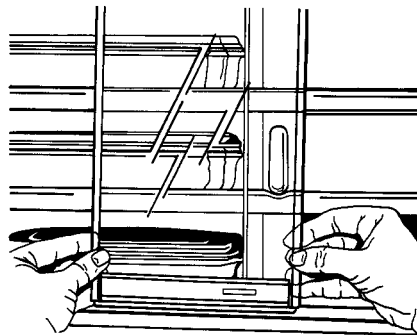

FIGURE 64

## Dairy Storage Shelves

The Dairy Storage Shelves within the dairy module can be removed easily for cleaning or storage of taller items.

1. Lift the front part of the shelf up and pull out at an angle. See Figure 65.

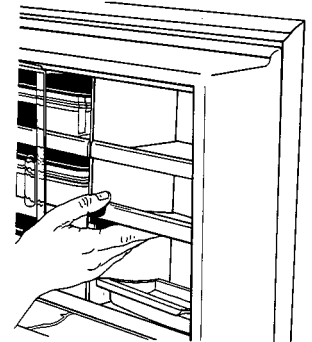

FIGURE 65

2. Slide the front trim right or left to remove from the shelf floor. See Figure 66.

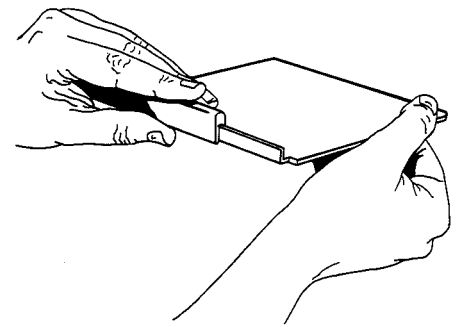

FIGURE 66

3. Replace the front trim by sliding the trim into the compartment area without the shelf. See Figure 67. When the shelves are removed either one or both sides can now be used as a tall package shelf. See Figure 68 and 69.

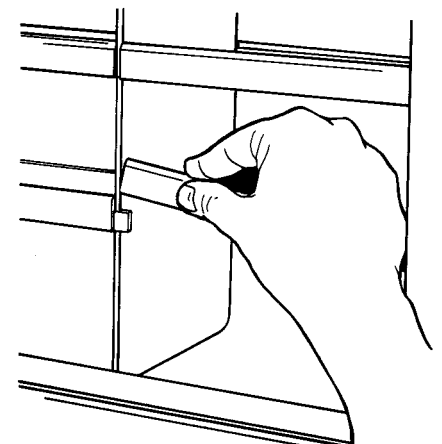

FIGURE 67

# Refrigerator Features (27 Cu. Ft. Only cont.)

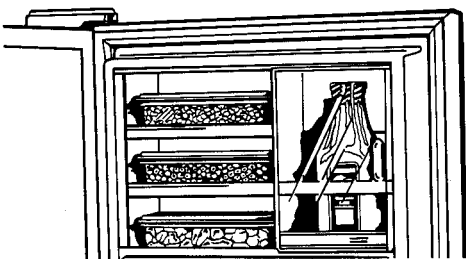

FIGURE 68



FIGURE 69

**Food Storage Containers.** Some models feature three durable left-over containers. See Figure 70. They store conveniently in this compartment and slide out for easy access. Containers are microwave\* and dishwasher safe. (Always place in the top rack of dishwasher).

**Note:** If containers should stain, follow manufacturer's instructions for cleaning.

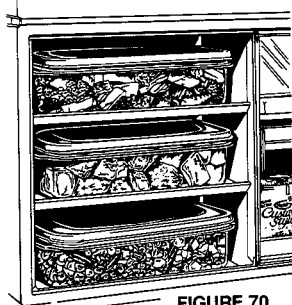

FIGURE 70

\*Note: Be sure to follow manufacturer's instructions, located in the containers when using containers to REHEAT foods in a microwave oven.

## Temperature Controlled Beverage Chiller

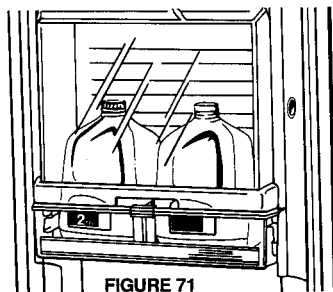

FIGURE 71

To gain access to the beverage chiller area slide the door upward. See Figure 72.

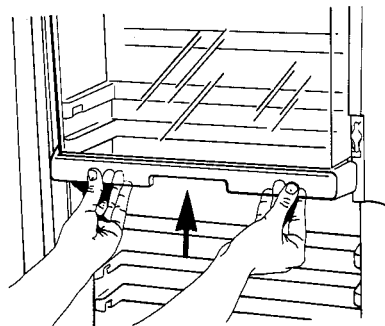

FIGURE 72

The sliding door will remain in the upward position until guided down to the closed position. See Figure 73. The extra deep door bucket allows for storing gallon size items and other large beverage containers.

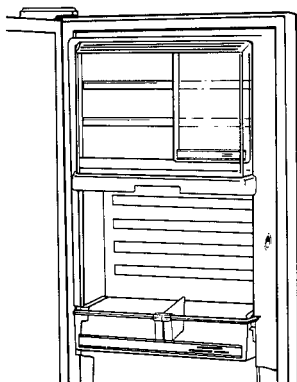

FIGURE 73

## Chiller Bucket Removal

The Chiller bucket may be removed easily for cleaning. To remove the bucket follow the instructions below.

1. Take hold of bucket. See Figure 74.

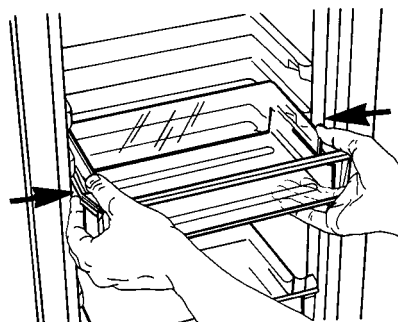

FIGURE 74

# Refrigerator Features (27 Cu. Ft. Only cont.)

2. Push the loc-tabs toward the center with your thumbs or forefingers, whichever is easier for you. See Figure 75. While holding in the loc-tabs, pull the bucket straight out.

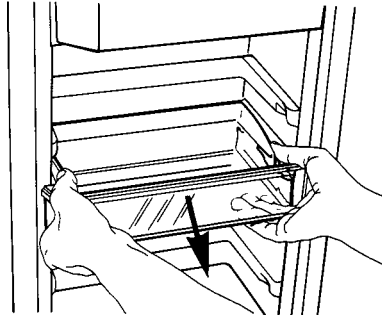

FIGURE 75

3. To install the Chiller Bucket, slide bucket into grooved area until the tabs lock into place. See Figure 76.

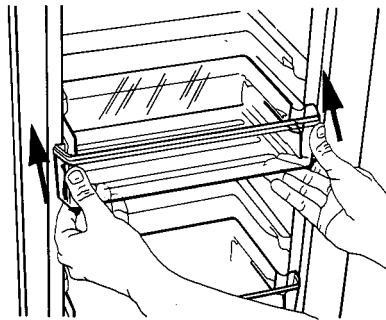

FIGURE 76

### Chiller Door Removal

The Beverage Chiller Door may be removed for cleaning by following the instructions below.

1. Remove the Chiller Bucket as stated above.
2. Slide door down and out through the bottom of the track. See Figure 77.

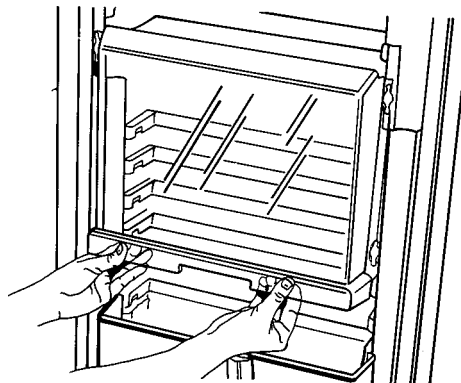

FIGURE 77

3. Take care to retain the four retention glides. See Figure 78. These will be needed to reinstall the door.

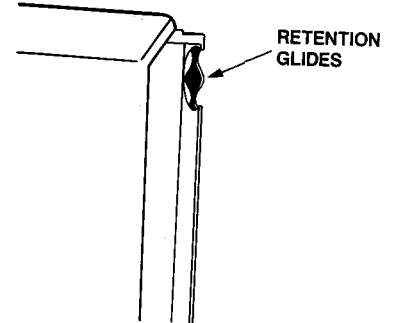

FIGURE 78

4. Reverse steps 1 and 2 to reinstall the door.

**Door Buckets.** There are three deep door buckets that can be moved up or down to fit storage needs. The deep door buckets allow for easy storage of six-pack items for convenience. See Figure 79. To remove the door buckets follow the instructions on page 29 for chiller bucket removal. To install the door buckets follow the instructions on page 30.

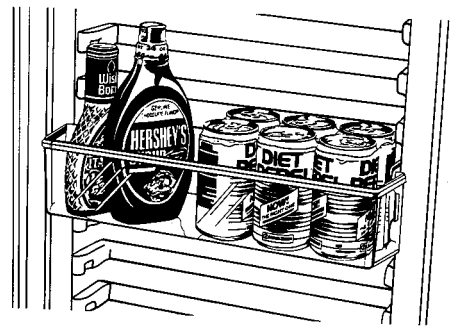

FIGURE 79

**Hugger.** A handy bucket hugger slides back and forth along 'chiller' bucket to prevent items from falling over. See Figure 80.

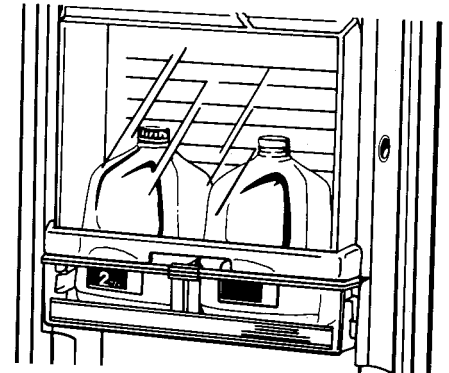

FIGURE 80

# Refrigerator Features (19, 20, 22 & 25 Cu. Ft. Models)

## Stor-Mor® Door (19, 20, 22 and 25 cu.-ft. Refrigerators)

**Egg Storage.** A removable take-to-counter egg bucket stores eggs in a see-thru covered container. See Figure 81. To clean, handwash in warm soapy water.

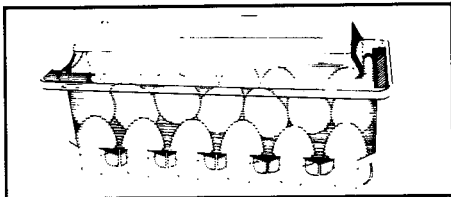

FIGURE 81

**Dairy Storage.** On 20, 22 and 25 cubic foot models, store butter and cheese in an adjustable dairy module complete with top door full-length shelf, two dairy compartments with sliding door and three food storage containers. The 19 cubic foot model features one large dairy compartment with two condiment trays and three food storage containers. See Figure 82. (**Note:** When washing butter dish, place dish on top rack of dishwasher.)

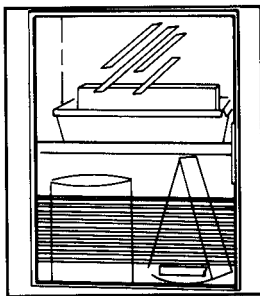

FIGURE 82

**Food Storage Containers.** Some models feature three durable leftover containers. See Figure 83. They store conveniently in this compartment and slide out for easy access. Containers are microwave\* and dishwasher safe. (Always place in the top rack of dishwasher).

**Note:** If containers should stain, follow manufacturer's instructions for cleaning.

\*Note: Be sure to follow manufacturer's instructions, located in the containers, when using containers to REHEAT foods in a microwave oven.

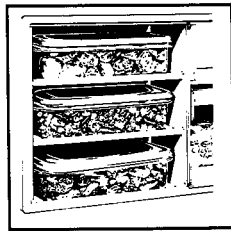

FIGURE 83

**Door Shelves.** Some models feature door shelves that can be moved up or down to fit storage needs. See Figure 84. To remove, loosen shelf by tapping upwards gently underneath both ends. Lift shelf slightly (1), then rotate bottom out and up to release mounting hooks from door slots (2). To install, tilt shelf and insert upper hook into any two door slots as shown. Rotate shelf bottom towards door and insert bottom hooks into door slots. Hold shelf against door and tap down gently on both ends until shelf is seated securely.

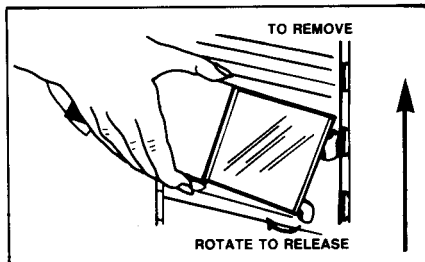

FIGURE 84

**Huggers.** Some models feature two handy shelf huggers that slide back and forth along door shelves. See Figure 85.

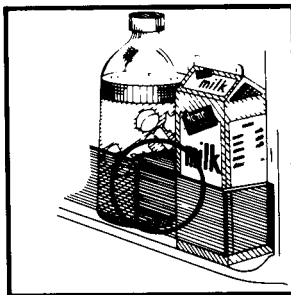

FIGURE 85

# Freezer Features

**Retainer Bar** is located above the ice chute. See Figure 86. The bar is removable for easy cleaning. Pull the bar left or right and up to remove. See Figure 87.

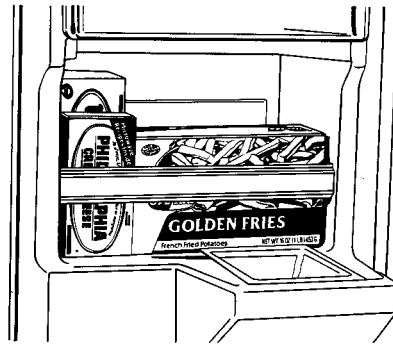

FIGURE 86

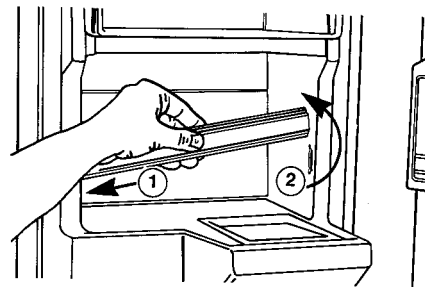

FIGURE 87

**Freezer Door Buckets.** The door buckets can be moved up or down to fit storage needs. To remove the freezer door buckets follow the same procedure as refrigerator door bucket removal on page 29.

**Large Glide-Out Freezer Basket**  
Stores odd-shaped, bulky food items.  
See Figure 88.

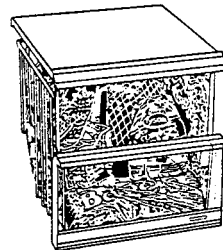

FIGURE 88

## Automatic Free-O'-Frost™ Operation

The freezer and refrigerator sections are completely frost-free. The Amana Frost-Magnet® evaporator coil in the back wall stops frost before it starts. Under normal operating conditions, you'll never have to defrost the unit, because it's automatic.

## Adjustable Freezer Shelves

1. To remove, press tabs on shelf support on right side of wall, lift shelf out of support tabs. See Figure 89.

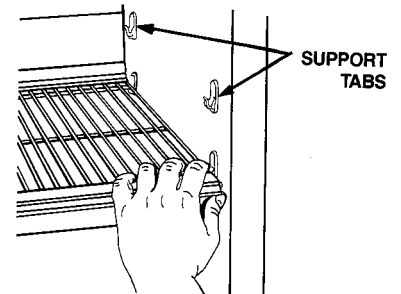

FIGURE 89

2. Pull shelf sideways and up until shelf rods come out of holes in the left wall. See Figure 90.

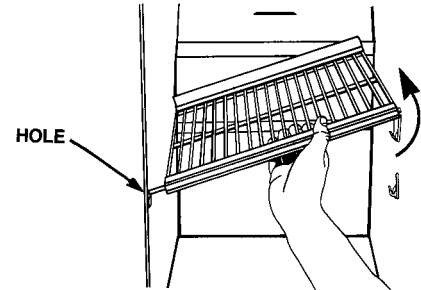

FIGURE 90

3. Select the desired shelf height and insert the shelf rods into the holes on the left wall, lower the shelf onto the support tabs and press down until the shelf snaps into place. See Figure 91.

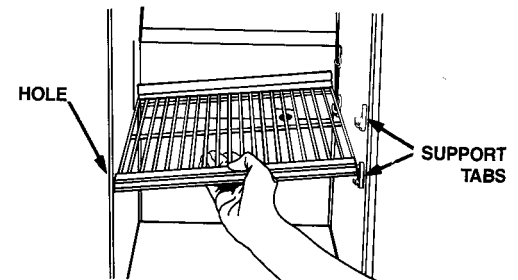
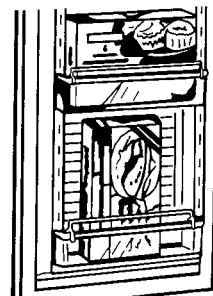

FIGURE 91

## Tall Package Retainer (20 & 27 cu. ft. Refrigerators)

Allows placement of tall packages in door buckets. Retainers will keep packages securely in place. See Figure 92.



## Freezer Features (cont.)



### Freezer Door.

The freezer door has three adjustable shelves, one non-adjustable shelf and one retainer bar. See Figure 93. To remove see instructions on page 29.

FIGURE 93

**Automatic Ice 'N Water™ Dispenser**  
See instructions beginning on page 10.

### Removable Door Dike (20 cu. ft. only)

Designed for kitchens when space limitations restrict opening of door to 90°. Removable door dikes (closest to hinges) will snap out to allow removal of freezer basket and ice bucket. To insert door dike align the four push clips to the holes on the freezer door. Snap in until the door dike is locked into place. See Figure 94.

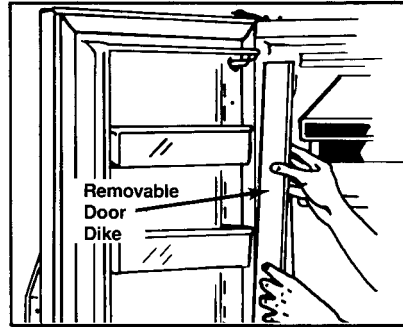

FIGURE 94

## Optional Features Available At Extra Cost

### **CAUTION:**

To Avoid Property Damage to soft vinyl flooring follow floor products manufacturer's recommendations when installing or moving the refrigerator.

Your Amana has several optional convertible features that you may purchase from your Amana dealer.

### Decorator Panels (Some Models)

These Amana units come from the factory with doors ready to decorate almost any way you want.

**Amana does not manufacture decorator panels for individual sale. Consult your dealer, cabinet maker or kitchen remodeler for sources.**

**Match wood cabinetry.** Your Amana dealer has a special 1/4-inch trim kit, available at extra cost, which allows you to have special wood panels built and installed on your unit so it matches the rest of your kitchen cabinets. (Panels not furnished.)

### How to install decorator panels.

#### Dimensions for 1/16" panels:

- **20, 22 and 25 cu. ft. models —**  
Upper Freezer Door Panel — 14 1/4" W x 17 5/8" H; Lower Freezer Door Panel — 14 1/4" W x 32 5/32" H; Refrigerator Door Panel — 18 15/32" W x 61 7/8" H.
- **19 cu. ft. model —** Freezer Door Panels — same as 22 and 25 cu. ft. models; Refrigerator Door Panel 14 23/32" W x 61 7/8" H.

**Tools Needed** — Standard screwdriver, Phillips screwdriver, masking tape and tightly fitted gloves.

1. **Remove trim cover from hinge side of door.** Tape tip and shaft of standard screwdriver to avoid marring the unit. Place screwdriver tip at top of trim cover next to hinge pin and push rear edge of trim out to the side. Working down the door, lift the rear edge of the trim cover to the side until it snaps off the trim retainers.
2. **Unscrew and remove the trim retainers.**

## Optional Features (cont.)

3. Guide panel into channels in the top and bottom trim and slide panel across the door and underneath the door handle. Press panel or squeeze door handle as needed.
4. Replace the trim retainer. Hook trim cover onto the front edge of the trim retainer, then gently tap back of cover with base of hand until cover is firmly seated along its entire length.
5. **NOTE:** On models having black handles and trim it will be necessary to modify a small black plastic shim located behind the top end of the upper trim piece on the handle side of the door. Remove shim by sliding part to the left on the freezer door and right on the refrigerator door. See Figure 95.

Modify per Figure 96.

Reinstall shim by simply sliding it back into place. See Figure 97.

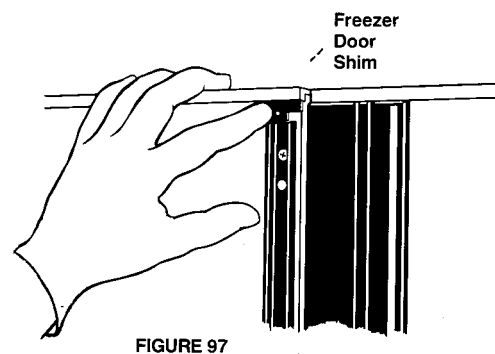
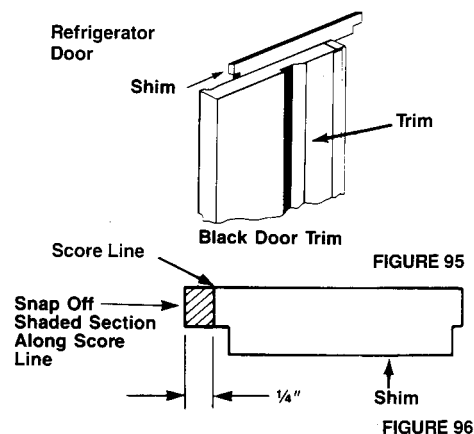

## Non-Use Periods

**Vacation Time.** If you will be away for vacation, remove perishable foods from the unit. Shut off the ice maker by turning off the water supply to the refrigerator and moving the ice maker wire arm to its upper-most position.

**Extended Periods of Non-Use.** If you are going to be away for longer periods, empty and unplug the unit. This will reduce needless operation and assure that food will not be spoiled if electrical service is interrupted. Just clean the unit as instructed in this manual and prop open the doors so air can circulate inside. Leave the unit unplugged. If the refrigerator has an automatic ice maker, turn off the water supply to the refrigerator.

**When You Move.** Unplug the unit and clean it. Use strapping tape or masking tape to secure all trays, shelves and other parts to prevent damage during shipment. Do not leave the unit closed for an extended period of time.

### If The Refrigerator Will Be Stored.

If the refrigerator will be stored or remain unused in a sub-freezing environment, remove the water and protect the water valve from damage as follows:

1. Disconnect the refrigerator from the electrical power source.
2. Shut off the refrigerator water supply. This can be done at the saddle valve where the 1/4" copper supply tubing joins the household water line. (Refer to illustration on back of cabinet.)
3. Remove the compressor compartment cover from the bottom rear of the refrigerator to reveal the water valve coupling. Place a small container under the valve to catch water spills. Remove the brass hose fitting from the valve. Label the two plastic tubes attached to the valve. Unscrew the compression nuts from the tubes and push the ends of the tubes away from their valve fittings. See Figure 98.
4. Blow the water out of the water dispenser plastic tubing with compressed air.

### Typical Water Valve Coupling

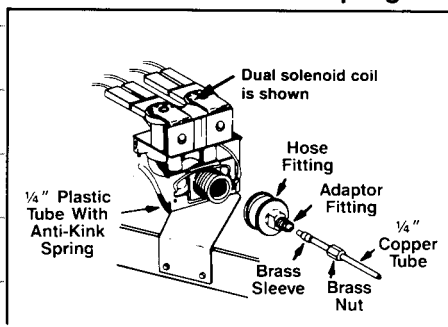

FIGURE 98



### CAUTION:

To Avoid Property Damage do NOT use tape that has "permanent" type adhesive!

Your new refrigerator may be replacing a smaller refrigerator of different design and/or a product which operated less efficiently. Steps have been taken in product design and operation of today's modern refrigerator which continue to provide the highest quality product, one which is energy efficient and operates as economically as possible. With this new design, you may hear sounds which are unfamiliar to you, yet quite normal and do **NOT** require a service call.

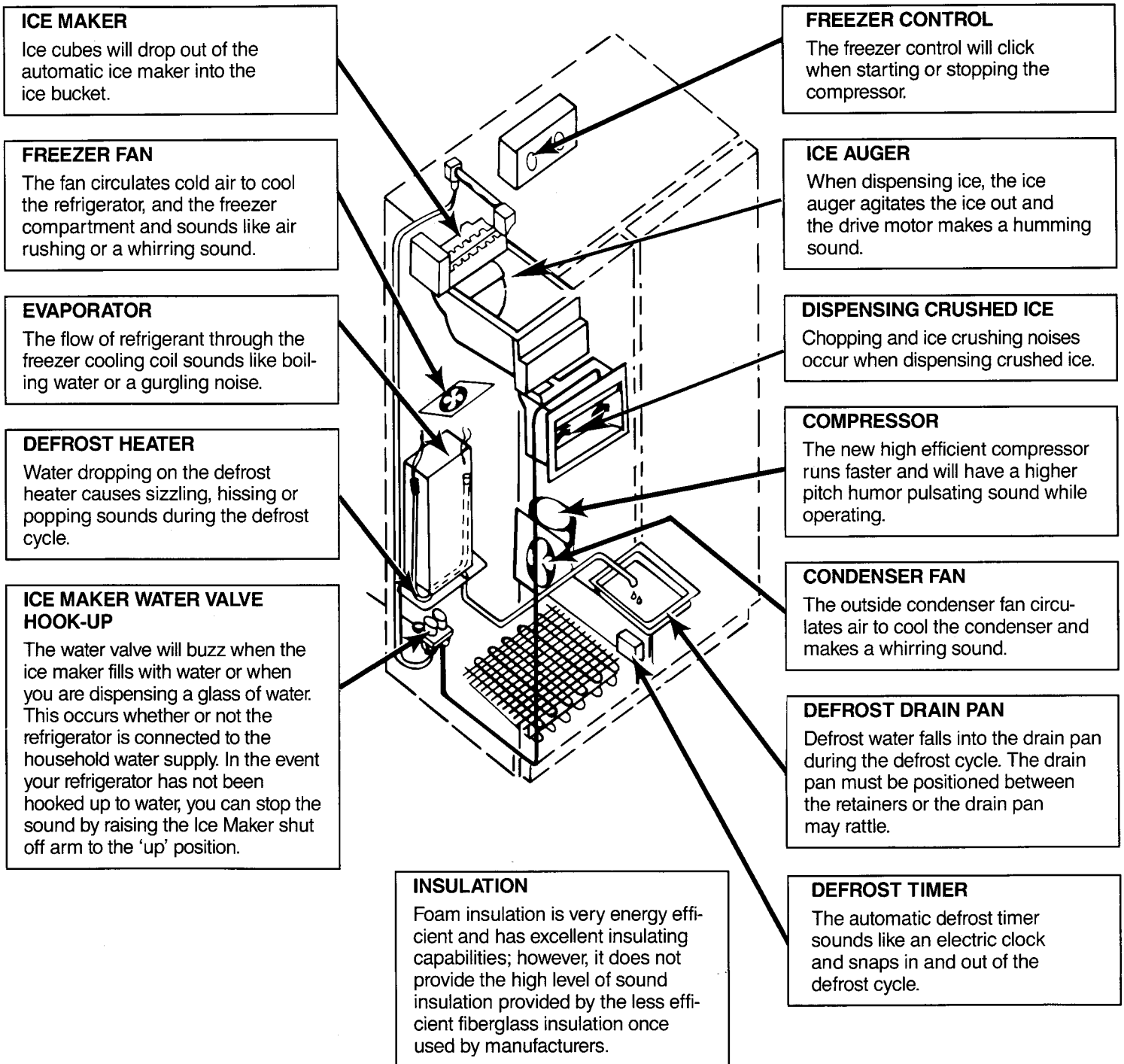

All of these sounds are usual and will soon become familiar. They indicate the unit is operating and performing as designed.

## Care and Cleaning

### **CAUTION:**

To Avoid The Risk Of Personal Injury use caution in unpacking, handling, removing, installing and cleaning all parts of product which may have sharp edges.

### **WARNING:**

To Avoid The Risk Of Electrical Shock Or Death turn off the power to the refrigerator by unplugging the power cord or opening the house circuit breakers before replacing a burned out light bulb or cleaning.

**NOTE:** Remove all food and special compartments from the freezer and refrigerator sections.

### **CAUTION:**

To Avoid The Risk Of Personal Injury wear protective hand covering.

**Exterior.** Wash with warm, soapy water, rinse and dry. **Note:** If your unit has factory installed black front panels do not use ammonia containing cleaners.

**Door Gaskets.** Clean at least twice a year with mild soap and water. Rinse and dry. Apply a light film of petroleum jelly to the gaskets on the hinge side to keep them soft and pliable.

**Interior.** Wash the liner with warm, soapy water. Rinse and dry. Interior components such as shelves, door buckets and drawers may be washed with 4 tablespoons baking soda dissolved in 1 quart warm water to "sweeten" these parts. Rinse and dry thoroughly.

Remove all food and special compartments from the freezer and refrigerator sections.

**Interior and Exterior.** DO NOT USE abrasive, heavy-duty powders such as AJAX cleanser, COMET cleanser, etc. when cleaning the interior or exterior of the refrigerator. These can scratch and dull the surface, depending on their abrasiveness and the cleaning pressure applied. Avoid metal pads and abrasive impregnated plastic, nylon and cloth pads such as CHORE-BOY® and

scouring pads, S.O.S.® and PADDY® soap pads, etc. These can scratch the baked enamel exterior and interior surfaces.

**Do not use** concentrated liquid dish-washing detergent (dissolve in warm water before using), abrasive cleansers, solvents or polishing agents on plastic parts. These cleansers may cause cracking or discoloring.

**Do not wash** plastic parts in an automatic dishwasher. They may warp. (The butter dish and food storage containers can be washed in a dishwasher.) See page 29 or 31 for details.

**The Dispenser Spill Shelf.** Should be wiped dry immediately with a soft cloth to prevent spotting. Wash with non-abrasive cleansers. Water deposits can be removed by soaking in undiluted vinegar.

**Ice Maker.** If your water has a high mineral content, the ice maker may require periodic cleaning. Cleaning with vinegar should remove most of the build-up. Contact your dealer for assistance with ice maker removal, cleaning and reinstallation.

**Clean Defrost Drain Pan.** The pan is located underneath the unit behind the toe grille. Every three months, remove the drain pan, wash it with warm soapy water, rinse and dry. When replacing the pan, make sure it is directly underneath the defrost water tube that extends from the back of the unit. Pull the toe grille forward to remove.

**Clean Condenser Coil.** The condenser coil is located behind the toe grille. Use a long-handle bottle brush and a vacuum cleaner to remove dust and lint from the coil. A suitable brush can be purchased from your Amana dealer. Dust and lint act as an insulator and prevent the coil from expelling heat taken from inside the unit. Failure to keep the coil clean will reduce cooling performance and efficiency.

**Reconnect Power Cord.** After cleaning, reconnect the power cord.

### **Odors**

If an offensive odor appears to be lingering in the refrigerator or freezer, the following procedures may eliminate the problem. Always begin with Method I. Use Method II and III only if the odor persists.

## Care and Cleaning (cont.)

### Method I

1. Unplug the unit.
2. Remove all food.
3. Thoroughly wash the inside of the unit, including all shelves, drawers, accessories and gaskets with a mixture of 4 tablespoons of baking soda dissolved in 1 quart of warm water. Pay special attention to any corners, crevices or grooves into which odor-causing liquid may have seeped. Dry thoroughly.
4. Return food to unit washing off all bottles, jars and containers before placing them into the refrigerator and freezer.
5. Plug in the unit. Wait 24 hours before checking to see if the odor has been eliminated. If the odor is still present, proceed with Method II.

### Method II

1. Unplug the unit.
2. Remove all food, making arrangements for other food storage. (The inside of the unit should already have been washed as instructed in Method I.)
3. Place crisper drawers on the top shelf of the refrigerator section.

4. Lightly crumple single sheets of newspaper. Loosely pack and fill the entire refrigerator and freezer interior with newspapers including door shelves, drawers and compartments.
5. Randomly place charcoal briquettes throughout the crumpled newspaper in both compartments.
6. Close the doors and let stand for 24 to 48 hours.
7. Remove the charcoal briquettes and newspapers. Wash and dry the inside of the unit as described in Method I.
8. Plug in the unit. Wait for 24 hours before checking to see if the odor has been eliminated. If the odor has been eliminated, then replace the food. If the odor persists, proceed with Method III.

### Method III

Order Delta Foremost's Original Country Club Cherry (a commercial neutralizing aerosol) from your nearest Amana authorized service center (Part number R1831-6). Use according to the instructions packaged with the aerosol. Remember to unplug the unit before beginning.

## You Can Help Save Energy!

Your New Amana Stor-Mor® Refrigerator/Freezer is designed to operate efficiently. You can help reduce energy consumption by following these suggestions:

**Energy Saver Control.** This control regulates special heaters that help reduce condensation during periods of high humidity. Reduce energy consumption by setting the control according to current climatic conditions.

**Refrigerated Meat Keeper.** Adjust the control to obtain the best storage conditions for highly perishable food items.

**Keep Freezer Section Full.** The unit operates more economically when the freezer is filled to capacity, but not over-filled. A full freezer helps maintain

frozen temperatures when the door is opened.

**Controls.** Set the freezer and refrigerator controls so the compartments are not colder than recommended. See page 17 for non-electronic models and pages 20 & 21 for electronic models.

**Doors.** Make sure the door gaskets do not become blocked, dirty or worn. Air leaks will cause the unit to operate more often.

**Location.** Install the unit away from heating equipment or direct sunlight.

**Keep the Condenser Coil Clean.** A dirty condenser coil will cause the unit to operate more than necessary. See page 36 for details.

## Before Calling For Service

Unnecessary service calls may be avoided by checking for the following common sources of difficulty. You will be charged for a serviceman's travel expenses and labor, even though the product may be in warranty, if the difficulty is not caused by *workmanship* or *material*, or if the component is *customer replaceable*. The following items are considered customer replaceable: defrost drain pan, door and cabinet shelves and drawers, butter dish, ice trays, light bulbs, egg bucket, huggers and accessories.

**Your refrigerator/freezer is designed for operation in a conditioned environment. For best performance your refrigerator should not be installed where surrounding temperature will be lower than 55°F. The compressor will not run frequently enough to maintain proper temperature. Operation in surrounding temperatures below 32°F. will result in defrosting problems and is not recommended for self-defrosting products.**

**If product does not appear to be operating:**

- Does the light work? A dim light indicates low voltage or a weak bulb.
- Is cord plugged in?
- Is a fuse or circuit breaker open? Check by plugging in another appliance or lamp at the same wall outlet.
- Has either of the doors been left open? Make certain food items stored within the refrigerator are not obstructing proper door closure. Check leveling of unit. (See page 9.)
- If the lights work and the freezer control is on, but the fan and compressor are not operating, the unit is likely in the defrost cycle. Wait 30 minutes to see if the unit will restart. If it does not, remove the toe grille. The defrost timer is located behind the grille (non-electronic only). Turn the timer knob clockwise until you hear a click. The refrigerator should begin running.

**If the unit still won't operate:**

- Be sure you have completed the steps listed above.

- Unplug the unit and take the steps necessary to preserve the food stored in the unit. Dry ice may be placed in the freezer section of the unit to preserve food until the unit can be serviced. Doors should be left closed until the unit has been repaired. Your product warranty does not cover food loss.
- Call your nearest Amana dealer or authorized service center listed in the Yellow pages.

**If food temperature appears to be warm:**

- See prior sections.
- Have you recently added a large load of food? Allow adequate time for the food to reach freezing temperature.
- Are any shelves covered with foil or plastic, preventing proper air flow?
- Is the condenser area clean? (See page 36.)
- Adjust freezer control. (See page 17.)

**If refrigerator section is too warm:**

- See prior sections.
- Adjust Temp-Assure refrigerator control. (See page 17.)

**If the Refrigerated Meat Keeper is too warm:**

- Is Meat Keeper inlet tube in place with the control outlet on the side wall?
- Slide Meat Keeper control to colder setting.
- Adjust freezer control to colder setting.

**If refrigerator food temperature is too cold:**

- Check Refrigerated Meat Keeper drawer assembly to see that inlet tube is in proper place over the outlet hole on side wall. If it is not properly connected, freezer air will spill into the refrigerator section. (See page 25.)
- Is condenser area clean? (See page 36.)
- Are any shelves covered with foil or plastic, preventing proper air flow?
- Adjust Temp-Assure refrigerator control. (See page 17.)
- Adjust freezer control to warmer setting. Allow several hours for temperature to change.

## Before Calling For Service (cont.)

### If the unit runs too much or too frequently:

- It may be normal to maintain an even temperature.
- Is condenser area clean? (See page 36.)
- Have doors been opened frequently or for an extended period of time?
- Is freezer running too cold? Adjust freezer control. (See page 17.)
- Check door alignment and gasket seal for proper closure.

### If the unit makes unfamiliar sounds such as popping or cracking; tapping, gurgling, boiling or bubbling; rumbling or rattling on shutdown:

- These may be normal operating sounds. Refer to page 35 for information on sounds the unit may make.

### If you hear running water in the unit:

- This is normal when the ice maker fills.
- This is normal when the unit defrosts and water enters the condensate pan.

### If you hear periodic buzzing:

- This is normal in cabinets with an automatic ice maker. The water valve will buzz when energized to refill the ice maker.

### If condensate forms on the inside of the unit:

- This is normal during periods of high humidity.

### If condensate forms on the outside of the unit:

- Is Energy Saver Control on highest setting? This will help reduce condensate.
- Check door alignment and gasket seal for proper closure.

### If Crisper or Meat Keeper drawers do not close freely:

- Check for package obstructing proper closure.
- Check to confirm drawer is in proper position in assembly.
- Apply thin layer of petroleum jelly to slide channel track.
- Make sure refrigerator is level.

### If there is an odor in the unit or ice cubes:

- Clean product. (See page 36.)
- Cover all foods tightly.
- Use freezer containers or freezer wrap.

### If ice forms in the inlet tube to the ice maker:

- Indicates sediment in solenoid valve which has not allowed the valve to close. An in-line water filter should be added. If problem persists the solenoid valve will need to be cleaned or changed.

### If the Cubed and Crushed Ice Dispenser becomes jammed:

- Dispense in the opposite mode. (See page 12.)

**Amana™**  
**Asure™**

**EXTENDED SERVICE PLAN**

### Rest assured against unexpected repair bills!

Amana is pleased to offer an important opportunity for long-term service protection on your new Amana appliance. The Amana Asure Extended Service Plan is specially designed to supplement the strong warranty that already accompanies your appliance, and it combines with this standard warranty to provide budget-protecting coverage on your appliance for up to five full years, covering parts, labor and travel charges.

Your participating Amana dealer has details. Or contact us:

**Amana Refrigeration, Inc.**  
**Customer Service Department**  
**Amana, IA 52204**  
**(319) 622-5511**  
**Monday through Friday**  
**(8 a.m.-4:30 p.m., C.S.T.)**

**Amana®**  
**FAST FACTS**  
 **1-800-843-0304**

Lined area for notes or specifications.